

Asada

REFRIGERANT RECOVERY MACHINE

ECOsaver V240SP

INSTRUCTION MANUAL

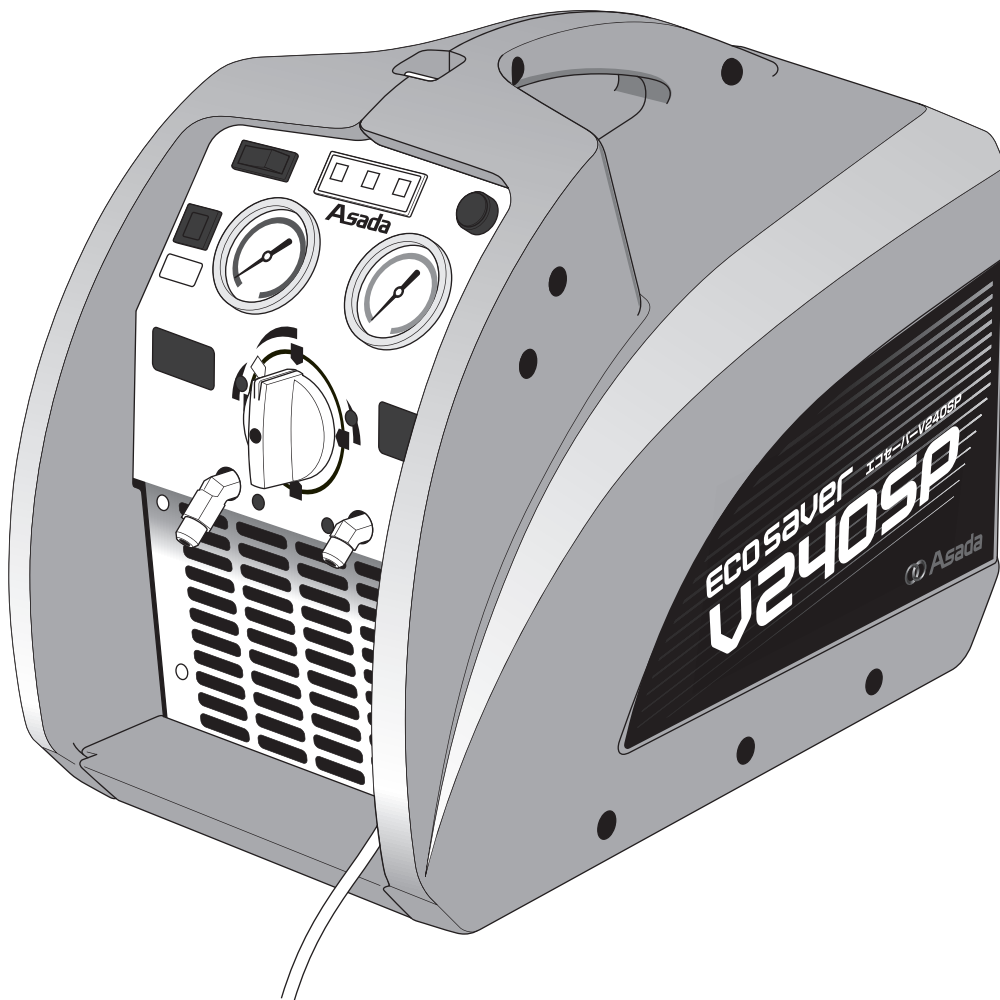

[Please read this manual before operating]

ECO saver V240SP

FOR SAFE OPERATION

Thank you for selecting ECOsaver V240SP.

- Please give this Operation Manual to the persons who operate this machine.
- The contents of this manual must be thoroughly read by the operating persons.
- Obtain the highest performance efficiency of this machine by an appropriate safe operation.
- Keep this manual at a safe place easily accessible by operating person.
- Do not use this machine for purposes other than originally intended.
- Check the following as soon the unit is delivered:
 - Is the specification same as the ordered product?
 - Is there damage or deformation caused during delivery transit?
 - Is there shortage of accessories?

If any dissatisfaction is found, please contact the store you have purchased or our sales department.
(The contents of this manual may be changed without prior notice for changes made for improvement.)

CATEGORIES OF WARNING SIGNS

The warning signs used in this manual or on the product are divided in the following two categories

 **WARNING** Situation that may cause death or serious injury if the operating Personnel contact or stand near the machine or the third party person Erroneously operates the machine.

 **CAUTION** Situation that may cause minor to medium injury or may cause damage to the machine, if the operating personnel contact or stand near the machine or The third party person erroneously operates the machine.



INDEX

WARNING FOR SAFETY	2	Recovery Procedure of R410A or	
COMPONENTS OF THE MACHINE	6	When the Pressure of Refrigerant is High	19
Name of Each Part	6	How to Restart the Recovery Machine	20
Specification	7	How to Recover Different Type of Refrigerant	20
Standard Accessories	7	In Case the Machine Stops During Operation	20
Optional Accessories (Recovery Cylinder)	8	RECOVERY CYLINDER	21
Optional Accessories (Other		MAINTENANCE & INSPECTION	22
Air-Conditioning Equipment)	8	BEFORE REQUESTING REPAIR	
HOW TO USE	10	OR SERVICES	24
Preparation before Operation	10	ELECTRIC WIRING DIAGRAM	25
Liquid/Vapor Recovery Procedure	12	FLOW DIAGRAM	26
Push/Pull Recovery Procedure	16		

ECOsaver V240SP

WARNING FOR SAFETY

- General warnings in operating this machine are mentioned in this section.
- While specific details are mentioned in each particular clause.

⚠ WARNING



- ◆ **When performing recovery, choose location that has good ventilation.**
Leakage of gas without sufficient ventilation may cause lack of oxygen cause suffocation.



- ◆ **Can not recover flammable gas (Hydrocarbon or this kind of hydrocarbon material) When mix except refrigerants [Ammonia, hydrocarbon(propane, isobutene,) etc] to the machine, it may cause explosion.**



- ◆ **Burning Freon creates a deadly poisonous Carbon Oxy-Chloride and inhaling of this gas is very dangerous.**
There should be absolutely no flammable material near the working area and must operate under good ventilation.



- ◆ **Absolutely no fire material and smoking during the work in process.**
Cigarette light may creates Carbon Oxy-Chloride and ignite fire.



- ◆ **Use protective eye glass and hand glove when disconnecting hoses.**
If Freon gas was touch your skin or gets in your eyes, it may cause frostbite or damage your eye-sight.



- ◆ **Do not close the valves of the machine and the hoses when they are full of liquid refrigerant.**
- ◆ **Do not operate or storage the machine at the place where temperature gets above 40°C .**
It may cause explosion for expand liquid gas on the higher temperature site. When the recovery operation will finish, do operation purge certainly.
- ◆ **Use our original recovery cylinders.**



- ◆ **Do not operate the machine with wet hands or in the rain.**
If you handle electric plug and power switch with wet hands or in the rain you may have electric shock.



- ◆ **Make sure to have the machine earthed (grounded).**
If the machine is not properly grounded, it may cause electric shock when the machine has electric leak.

ECOsaver V240SP

WARNING



- ◆ **Check electric power plug regularly to make sure there is no problem. Always have the plug inserted firmly.**

When the plug has dirt or oil, and the connection is incomplete, it may cause electric shock or fire.



- ◆ **Do not have the electric cord connected with other electric devices or branched with other cords.**

It may cause fire.



- ◆ **Do not pull the electric power source cord and remove from the outlet.**
It may cause fire or injury.

- ◆ **The power source should be AC220-240V 10A or use a generator whose capacity is 3KVA or more.**

If the capacity of the generator is not large enough, it may lead to heating, smoking or fire.

See the machine plate or this manual for the detailed specifications.



- ◆ **Do not setup the machine at location where gasoline, thinner, or flammable Gas exists.**

The recovery machine sparks at the start-up time and may ignite gasoline and thinner.

If leaked gasoline or flammable gas accumulates at near the machine, it may cause explosion and fire.



- ◆ **Always turn off the switch and pull out the power source cord when performing inspection and maintenance.**

The machine may suddenly starts and cause accident.



- ◆ **Do not disassemble by un-authorized repair person.**

- ◆ **Do not operate the machine with the cover removed.**

It may cause abnormal movement and may cause injury or damage.

ECOsaver V240SP

CAUTION



- ◆ **Install a filter at the suction port.**
Otherwise the compressor may be damaged.



- ◆ **An extension cord used should be a three-core cable with a length of 20m or less when its wire diameter is 2.0mm² or with a length of 30m or less when its wire diameter is 3.5mm².**



- An unsuitable extension cord (too thin or too long) may lead to starting failure or fire. Or electrical components such as capacitor, relay and so on may be damaged.
If the cord used is a two-core cord without a ground wire, you may get electric shock.



- ◆ **Do not recover refrigerant which contains sealant.**
Sealant may clog the valves or the check valves.

- ◆ **Refrigerant which is unsure if it is liquid or vapor to be recovered at the valve adjusted to LIQUID RECOVERY with less suction pressure.**
If liquid refrigerant goes into the compressor under the vapor recovery procedure, the compressor may be damaged.

- ◆ **Do not let visitors touch the machine.**

- ◆ **Do not use the machine when the result is unpredictable.**

- ◆ **Do not use the machine for purposes other than the original intent.**
This machine is designed to recover the specified refrigerants.

- ◆ **Do not operate under an excessive heavy load to the machine.**
Operating under an excessive load can not only cause damage to the machine but also causes an accident.

- ◆ **Do not use the machine on a vibrating floor or on a sloping place.**
The machine or the cylinder may fall down and lead to accident.

- ◆ **The operating platform and the work area must be kept neat and clean at all time and have enough lighting.**
Poor working environment causes accident.

- ◆ **Do not operate the machine if the operator is under fatigue condition or influenced by alcoholic drink or medicines.**

- ◆ **When the Recovery Machine is not in use, storage at dry space and out of reach by children.**

- ◆ **Do not use accessories other than referred in this manual or shown on our catalogue. Use of other accessories may cause problem.**

ECOsaver V240SP

CAUTION



- ◆ **When the Recovery Machine is dropped or hit, inspect immediately for damage, crack, dent, etc.**

Recovery under damaged, cracked and dented condition may cause injury

- ◆ **Check every day if there is deformed or corroded area.**



- ◆ **If abnormal condition (strange smell, vibration, strange noise) is noticed, stop the unit and refer to the Page24 “BEFORE REQUESTING REPAIR OR SERVICES” in the manual.**



- ◆ **Request for repair or service instead of disassembling for repair, contact the store where the machine was purchased.**



- ◆ **Use our cylinders that are expressly made for recovery and recycling.**



- ◆ **Evacuation should not be done when the Auto stop/run switch is at the “Auto stop” position.**

Air may be left in the machine.

Low pressure switch trips to stop the machine when the suction pressure of the compressor is approximately -26cmHg/-10inHg and be released automatically when the pressure goes up.

- ◆ **Close the valve of cylinder certainly when not in use.**



Cautions for recovery of R32, R1234yf, R1234ze (specific inert gas)

- ◆ **Do not recover where ignitable things and inflammables exist.**

- ◆ **Prepare a fire extinguisher for unexpected condition.**

ECO saver V240SP

COMPONENTS OF THE MACHINE

Name of Each Part

Labels are required by law for safety and the warnings are placed on the recovery machine. If the label comes off the machine or became dirty and unreadable, request us for new label. Replace the label at the same position on the machine.

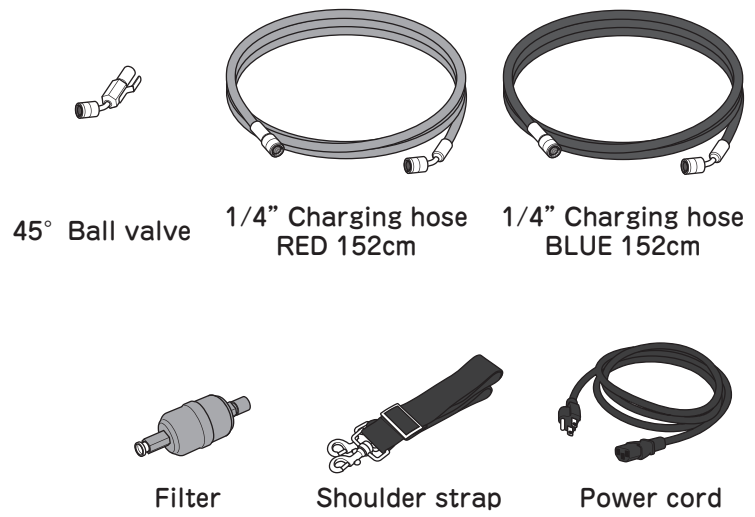
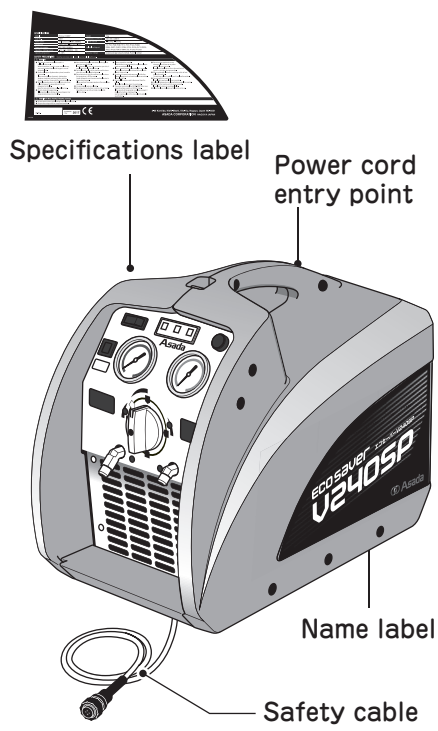
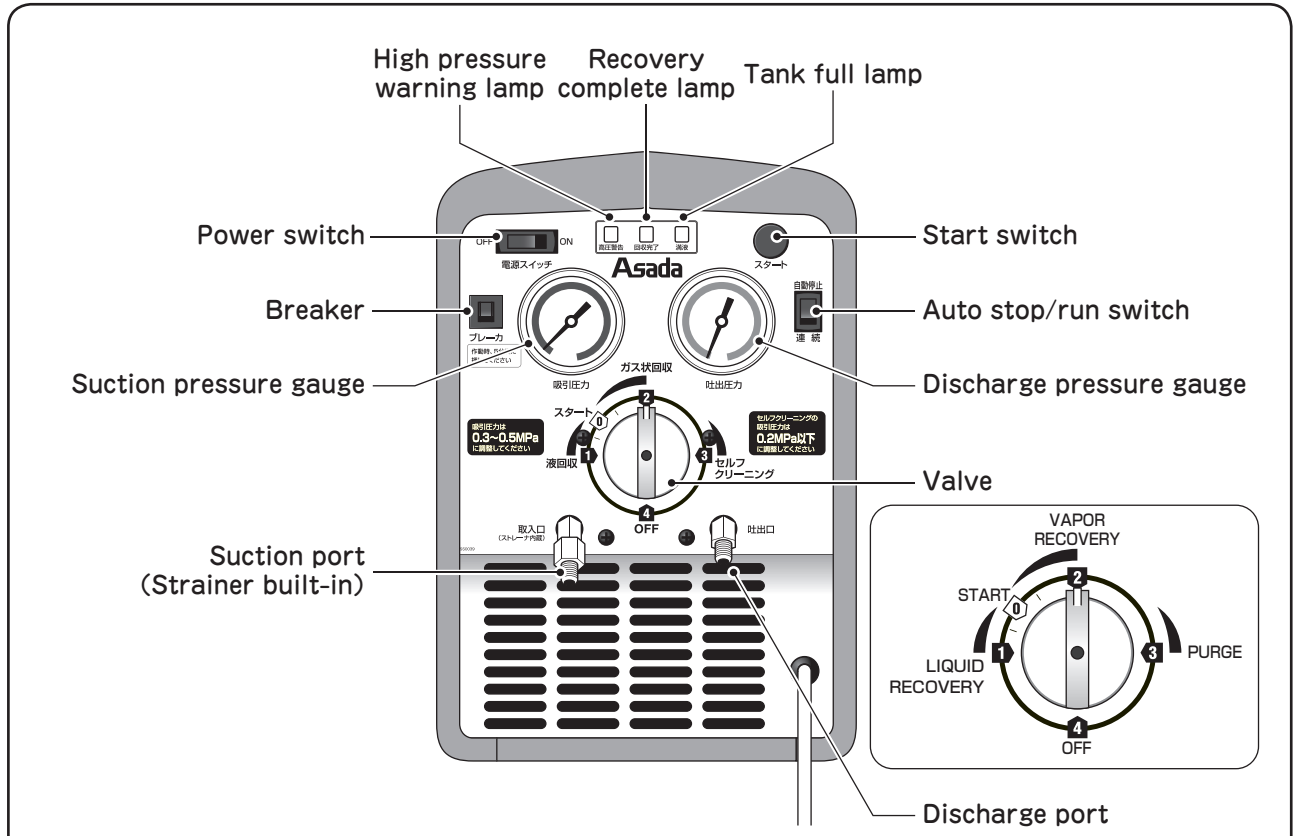

ECOsaver V240SP

Specification

Model	ECOsaver V240SP
Code No.	ES641
Recovery method	Compressed vapor recovery method, Push/Pull method
Dimensions	440 x 265 x 360mm (L x W x H)
Weight	15kg
Compressor	750W (1HP) Oil less twin cylinders
Power source	Single phase 220-240V (50/60Hz)
Applicable refrigerants	R12, R22, R500, R502, R114, R124, R134a, R403B, R404A, R407C, R407D, R410A, R412A, R413A, R417A, R422A, R422D, R423A, R507A, R509A, R32, R1234yf, R1234ze
Power consumption	685/730W (50/60Hz)
Operating · Starting current	3.7A / 3.6A (50/60Hz) · 28A
Operating temperature	0 ~ 40°C
Ultimate vacuum	- 68cmHg/ - 27inHg
Applicable cylinder	Float sensor type : Recovery cylinder (with float sensor) 6L · 12L · 24L · 40L · 120L
	Weighing type : Recovery cylinder (without float sensor) with Limit Scale 12L · 21L · 24L · 40L · 120L

Recovery rate	R22	R410A
Vapor (g/min)	230	240
Liquid (g/min)	2,530 (Vapor recovery * 1)	2,750 (Vapor recovery * 1)
	1,060 (Liquid recovery)	1,240 (Liquid recovery)
Push/Pull (g/min)	6,150	7,300

* 1 When the valve is at the "Vapor recovery" position.(Room temperature 25°C)

* Specifications are subject to change without prior notice.

* Recovery rates vary under different conditions.

Standard Accessories

Description	Code No.
ECOsaver V240SP main unit	—
1/4" Charging hose RED 152cm x 1 pce	AI133
1/4" Charging hose BLUE 152cm x 1 pce	AI137
1/4" Ball valve 45° (male x female)	Y93843
Adapter for different diameter 5/16" female x 1/4" male	Y06110K
Filter dryer 032F	ES006
Shoulder Strap	ES253
Power cord	ES305
Instruction manual	IM0436
Operation manual	IM0437

ECOsaver V240SP

Optional Accessories (Recovery Cylinder)

Description	Capacity	Port	Code No.
Refrigerant recovery cylinder (with float sensor)	1L	1/4" flare	TF040
	6L		TF090
	12L		TF056
	24L		TF057
	40L	1/4" flare	TF130
		3/8" flare	TF131
	120L	1/4" flare	TF110
		3/8" flare	TF129
		1/2" flare	TF097
		3/4" flare	TF098

Description	Capacity	Port	Code No.
Refrigerant recovery cylinder (without float sensor)	24L	1/4" flare	TF080
	120L		TF070

* Our Limit Scale must be used when recovery cylinders (without float sensor) are used.

* Our original recovery cylinder should be used.

Optional Accessories (Other Air-Conditioning Equipment)

Name of Item	Code No.	Explanation of the Item
Limit Scale LS-45 II	LS452	Scale to be used to prevent over-filling when recovery cylinder has no float sensor.
Limit Scale LS-150 II	LS152	
Filter	TF011	Removes impurities and small particles from the refrigerant to be recovered to protect the machine.
Filter dryer 032	ES058	Removes oil, moisture, acid, impurities and small particles from the refrigerant to be recovered to protect the machine.
Vacuum pump 1.8CFM Eco	WV210	High efficient 2-stage vacuum pump with a check valve.
Cordless Vacuum Pump 1.5CFM	VP151	Useful where has no power source.
Cooling unit CL3 (3/8")	ES801	Improves the efficiency of recovery in summer climate, recovery in a large volume or recovery of R410A by using together with a recovery machine.
Header	TF013	Recovery of up to 6 units at the same time.
Piercing valve	TF014	Makes a connection port for recovery from a system which has no service port such as a home use refrigerator, etc.
Solenoid valve opener	RF4660507	Opens the solenoid valve on the refrigeration system forcibly to recover refrigerant completely.
1/4" Charging hose with pressure gauge (for use with cylinder)	Y02002A	Connect to recovery cylinder and check the amount of air mixed in the refrigerant.
1/4" Hose with vacuum gauge	Y02003A	Checks depth of vacuum in the system being recovered to judge completion of recovery.
Sight Glass	ES603	Visually check refrigerant flow either in vapor or liquid.
Adapter for different diameter for auto A/C (quick type) 3/16" female x 1/4" male	Y19120	Adapter to connect to the small service port (3/16") for R12.
High pressure quick joint for R134a (M12)	Y03100A	For quick connection to the service port (high pressure side) for R134a.
Low pressure quick joint for R134a (M10)	Y03200A	For quick connection to the service port (low pressure side) for R134a.

ECOsaver V240SP

Optional Accessories (Other Air-Conditioning Equipment)

Name of Item	Code No.	Explanation of the Item
1/4" Hose with ball valve (male x female)	Y25980	Short hose with ball valve which prevents refrigerant from discharging to the air when the hose is disconnected.
1/4" Ball valve 45° (male x female)	Y93843	Prevent release of refrigerant when Disconnecting hose.
Quick charging valve A.	Y18975	Can be used without leaking refrigerant. Recovery speed improves without Schrader.
Charging hose plus II with SealRight fitting	Various sizes available	Low loss anti-blow back SealRight fitting traps refrigerant in the hose when disconnected.
Charging hose plus II for R410A		Charging hose for R410A.
Charging hose plus II with ball valve for R410A		Charging hose with ball valve for R410A.
Charging hose plus II for R134a		Charging hose for R134a.

ECOsaver V240SP

HOW TO USE

Preparation before Operation

1) Environment of Usage

- “Transportation” and “Evacuation of the air in the cylinder” should be done in view of the following environment of usage.

- ① Do not use the machine in rain or in areas where water may enter into the machine.

A fan is built into the machine for cooling and it may suck water.

- ② The recovery machine should be used in a well-ventilated area.

When the machine is used in a poor ventilated area, you may be choked from lack of oxygen in case of refrigerant leak.

- ③ Keep fire away to prevent phosgene (highly toxic substance) being generated.

- ④ Combustible gases (hydrocarbon system) cannot be recovered.

If any combustible gases [ammonia, hydrocarbon (propane, isobutene) and so on] enter into the recovery machine, it may catch fire and may explode.

- Please note the following points before use.

- ① Check the type of refrigerant to be recovered.

- ② Evacuate the air from the refrigerant recovery machine, charging hoses and recovery cylinder (hereinafter called recovery machine, hoses and cylinder).

- ③ Install a filter or a filter dryer at the suction port of the recovery machine.

- ④ Set the valve to the “① START” position before starting the recovery machine.

- ⑤ Abnormal noise may be heard when a large amount of damp refrigerant enters into the compressor during liquid recovery.

Throttle the valve on the manifold until the noise cannot be heard.

- ⑥ Do not close the valve of the hose or the valve of the cylinder before stopping the recovery machine during operation.

The gauge may be damaged.

Close the system side valve of manifold, turn “OFF” the machine after set the valve to “① START” .

- ⑦ The temperature of the cylinder may rise when the ambient temperature is high or R410A is recovered.

Lower the temperature and pressure of the cylinder according to “page 11 4) Helpful Information” and “page 19 Recovery Procedure of R410A or When the Pressure of Refrigerant is High” .

- ⑧ Do not enter the air into the hoses and the cylinder.

When the cylinder contains air, evacuate the air from the vapor valve referring to the chart of saturation temperature and pressure.

The air can be evacuated before discharging the refrigerant.

- ⑨ Use an oil separator when refrigerant with a large amount of oil is recovered.

The compressor may be damaged when a large amount of oil is recovered.

- ⑩ Do not recover virgin refrigerant.

The compressor may be damaged if virgin refrigerant is recovered for a long time.

If you need to recover virgin refrigerant, put some additional oil in the compressor.

- ⑪ Do not recover from air conditioners in which any sealant has ever been charged.

The sealant may clog the valves or the compressor and the recovery machine may be damaged.

- ⑫ Do not evacuate the air from the cylinder by using the recovery machine.

The compressor may be damaged if it is run for a long time under vacuum.

- ⑬ When starting the machine, it may not start unless the pressure in the compressor is equalized.

Start the machine after equalizing the pressure at the discharge side and the pressure at the suction side of the compressor according to “page 20 How to Restart the Recovery Machine” .

2) Transportation

- All connections between the recovery machine and the cylinder should be disconnected during transportation.

⚠ CAUTION



- ◆ All connections between the recovery machine and the cylinder should be disconnected during transportation.
- ◆ Steer clear of injuries when you carry a heavy cylinder.

ECOsaver V240SP

3) Preparation of Cylinder

- Use our original recovery cylinders.
- Use cylinders on which the type of refrigerant to be recovered is mentioned.
- Empty cylinders should be evacuated before use.

⚠ CAUTION



- ◆ The cylinder is designed according to the specifications of the recovery machine. The cylinder may be overfilled and exploded if the appropriate cylinder is not used.

- How to evacuate air (Vacuum pump is optional)

⚠ CAUTION



- ◆ Brand-new cylinders have nitrogen inside. Evacuation should be done after discharging nitrogen by opening the vapor valve.
- ◆ Do not evacuate air from cylinders which contain refrigerant. The refrigerant will be discharged to the air and the vacuum pump oil will blow out.
- ◆ Do not evacuate air from cylinders by using the recovery machine. The compressor may be damaged if it is run for a long time under vacuum.

- ① Connect the suction port of the vacuum pump to the vapor port of the cylinder with a hose.
- ② Switch on the vacuum pump.
- ③ Close the liquid port of the cylinder and open the vapor port.
- ④ Close the vapor port of the cylinder when the vacuum reaches $-72\text{cmHg}/-28\text{inHg}$ to $-76\text{cmHg}/-30\text{inHg}$.
- ⑤ Switch off the vacuum pump.
- ⑥ Disconnect the hose between the vacuum pump and the cylinder.

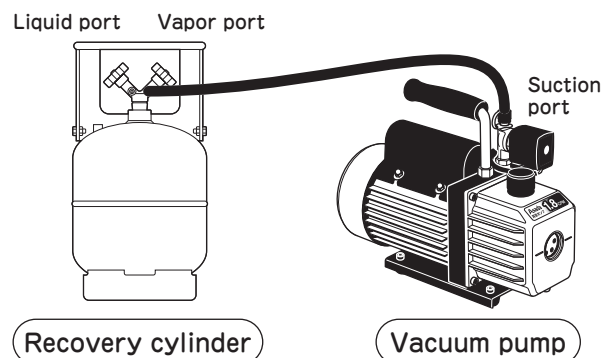

4) Helpful Information

- How to shorten the recovery time

- ① After liquid recovery is completed, recover from both the liquid and the vapor ports.
- ② Remove the valve cores of the service ports of the system if they have.
- ③ Remove the core depressors of the charging hoses.
- ④ Use large size 3/8" hoses.
- ⑤ Replace the gaskets of the hoses if they are deformed.
- ⑥ Recover refrigerant while operating the crank case heater of the system.
- ⑦ Heat up the accumulator by a heat gun or give it vibration if it is frozen.
- ⑧ Recover from multiple systems in one time.

- How to avoid rise in temperature and pressure in the cylinder

- ① Put the recovery machine in a well-ventilated shady area.
- ② Do not put the recovery machine and the cylinder directly on the floor but put them away from the floor.
- ③ Cool down the cylinder with wet cloths.
- ④ Use Cooling Unit (optional accessory) (See page 19).
- ⑤ Reduce the suction pressure of the recovery machine (See page 19).
- ⑥ Replace the cylinder with an empty one.
- ⑦ Cool down the cylinder with the sub-cooling procedure (See page 19).
- ⑧ Use a 120L cylinder.

ECOsaver V240SP

Liquid/Vapor Recovery Procedure

⚠ CAUTION

◆ When the recovery machine stops with “High pressure warning” · ” Recovery complete (Auto stop)” · ” Tank full” , remove the cause before pushing the Start switch.

1) Connection of the hoses and cords

- This recovery method is the most basic and popular method.
Do not try other methods (Push/Pull recovery and so on) unless you master this method.

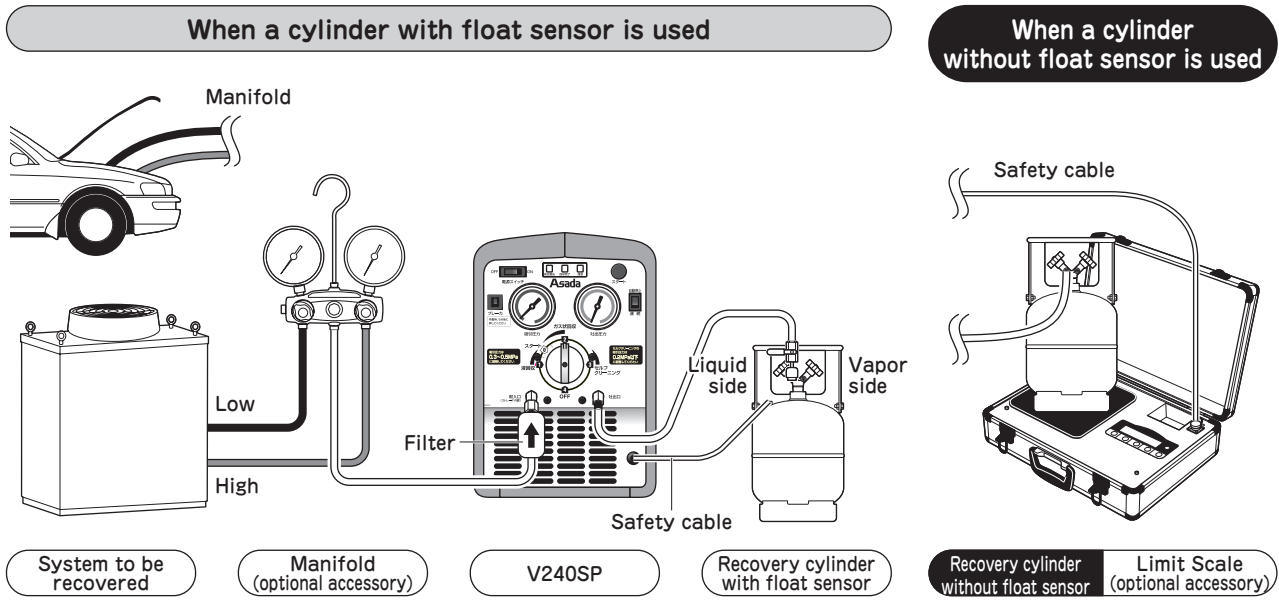

① Connect the hoses as above.

⚠ CAUTION

◆ Use our Limit Scale (Code No. LS452,LS152) when a cylinder without float sensor is used.

② Connect the safety cable to the connector on the cylinder or on Limit Scale.

⚠ CAUTION

◆ The recovery machine will not start without connecting the safety cable.

③ Install a filter to the suction port of the recovery machine.

⚠ CAUTION

◆ Make sure the installing direction.
◆ Replace the filter every recovery of 90kg or when it is clogged.

ECOsaver V240SP

2) Evacuation of the air from the recovery machine and the hoses

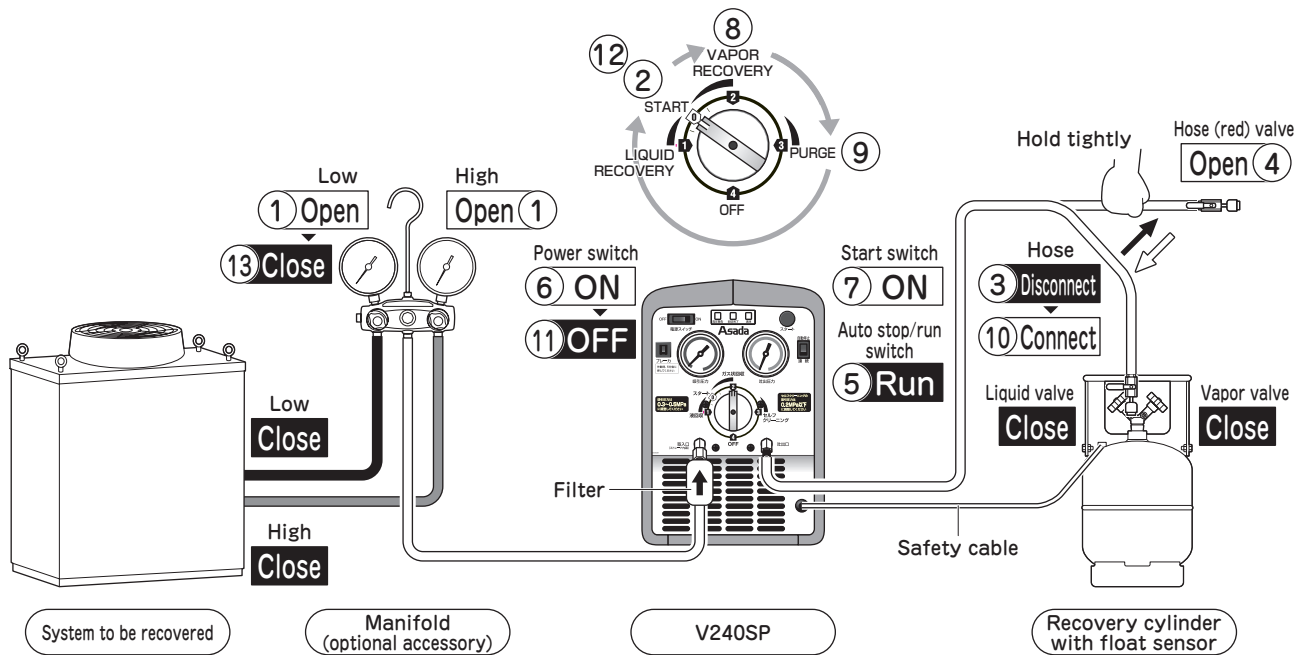

Valve operation

- ① Open the low pressure side and the high pressure side valves of the manifold.
- ② Set the valve of the recovery machine to the "① START" position.
- ③ Disconnect the hose connected to the liquid port of the cylinder.
- * Hold the hose tightly.
- ④ Open the ball valve of the hose.

Operation

- ⑤ Set the Auto stop/run switch to the "Run" position.
- ⑥ Set the Power switch to the "ON" position.
- ⑦ Push the Start switch
- * Do not set the Auto stop/run switch to the "Auto stop" position.
Air may be left in the machine.
- * Let the unit "Auto stop" by error, change Auto stop/run switch to "Run" and push Start switch.
- ⑧ Set the valve of the recovery machine to the "② VAPOR RECOVERY" .
- ⑨ When the discharge pressure reaches to a vacuum, set the valve of the recovery machine to the "③ PURGE" position.
- ⑩ When the discharge pressure reaches to vacuum again, connect the hose to the liquid port of the cylinder.
Close the ball valve of the hose.

End of operation

- ⑪ Set the Power switch to the "OFF" position.
- ⑫ Set the valve of the recovery machine to the "① START" position.
- ⑬ Close the low pressure side valve of the manifold.

ECO saver V240SP

3) Recovery procedure

- Recover from the high pressure side of the system in case of liquid recovery and recover from the low pressure side in case of vapor recovery.
- Recover from the high pressure side (liquid refrigerant) when a large volume of refrigerant (5kg or more) is recovered in one time.

⚠ CAUTION



- ◆ Refrigerant inside the system, which is unsure if it is liquid or vapor, to be liquid recovered with the valve adjusted to “① Liquid recovery” with less suction pressure.
- ◆ Throttle the valve of the manifold to regulate the suction pressure to approximately 3kg/cm²/43.5psi when the pressure in the system is very high in summer or during vapor recovery.
- ◆ Use an oil separator when refrigerant with a large amount of oil is recovered.

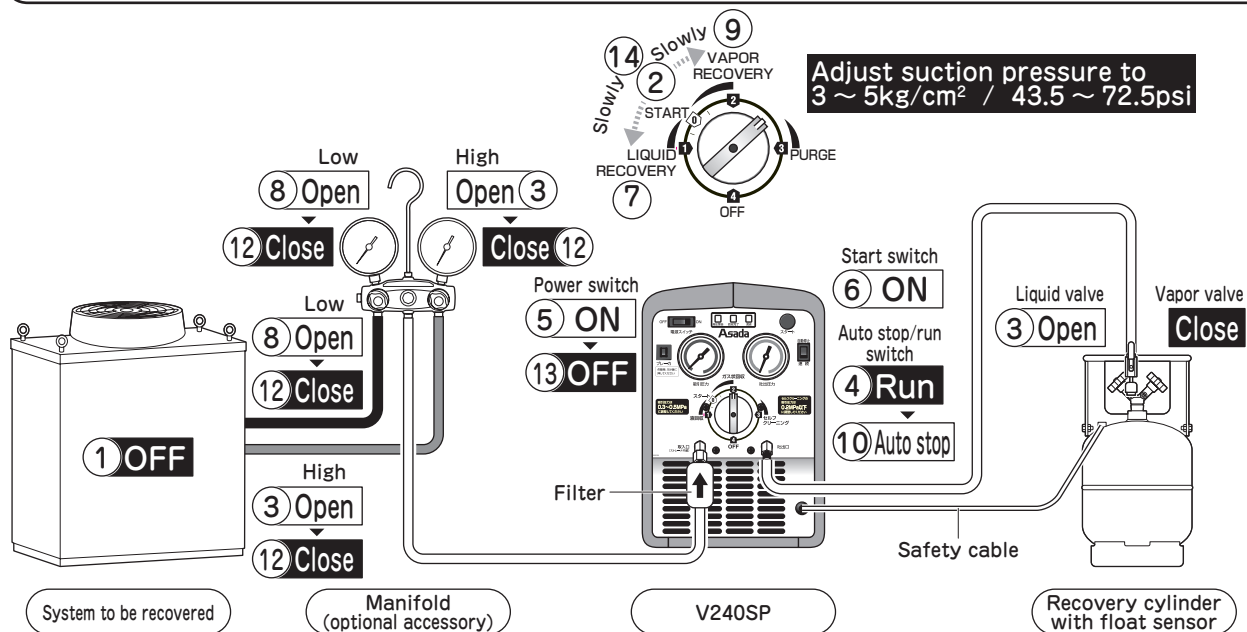

Valve operation

- ① Switch off the system to be recovered.
- ② Set the valve of the recovery machine to the “① START” position.
- ③ Open Liquid valve of the cylinder and High Pressure valves (Liquid side) of manifold and the system.

Operation

- ④ Set the Auto stop/run switch to the “Run” position.
 - ⑤ Set the Power switch to the “ON” position.
 - ⑥ Push the Start switch.
 - ⑦ Turn the valve slowly to the “① LIQUID RECOVERY” position.
- * Adjust suction pressure with valve to 3 ~ 5 kg/cm² / 43.5 ~ 72.5psi.

- * The valve position showing in the drawing at the right is standard for 3kg/cm² / 43.5psi.

- ⑧ When liquid recovery is completed and vapor recovery starts, open the valve of the low pressure side of the manifold and the port of the low pressure side of the system to be recovered.

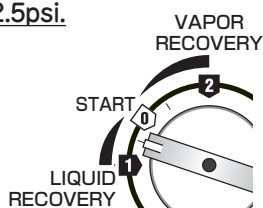

- ⑨ Turn the valve slowly to the “② VAPOR RECOVERY” position.

* Adjust suction pressure with valve to 3 ~ 5 kg/cm² / 43.5 ~ 72.5psi.

* The valve position showing in the drawing at the right is standard for 3kg/cm² / 43.5psi.

* When the cylinder is full, the Tank full lamp is on and the recovery machine stops.

- ⑩ Set the Auto stop/run switch to the “Auto stop” position.

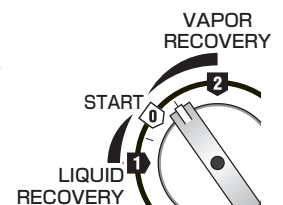

End of operation

- ⑪ When the suction pressure reaches to -26cmHg/-10inHg, the Recovery complete lamp is on and the recovery machine stops automatically.
- ⑫ Close both the low side and the high side ports of the system.
- ⑬ Set the Power switch to the “OFF” position.
- ⑭ Set the valve of the recovery machine to the “① START” position.

ECOsaver V240SP

4) Refrigerant clearing (Purge) procedure

⚠ CAUTION



- ◆ Always perform the purge procedure after completing recovery.
The recovery machine may be damaged if any refrigerant is left in the machine.

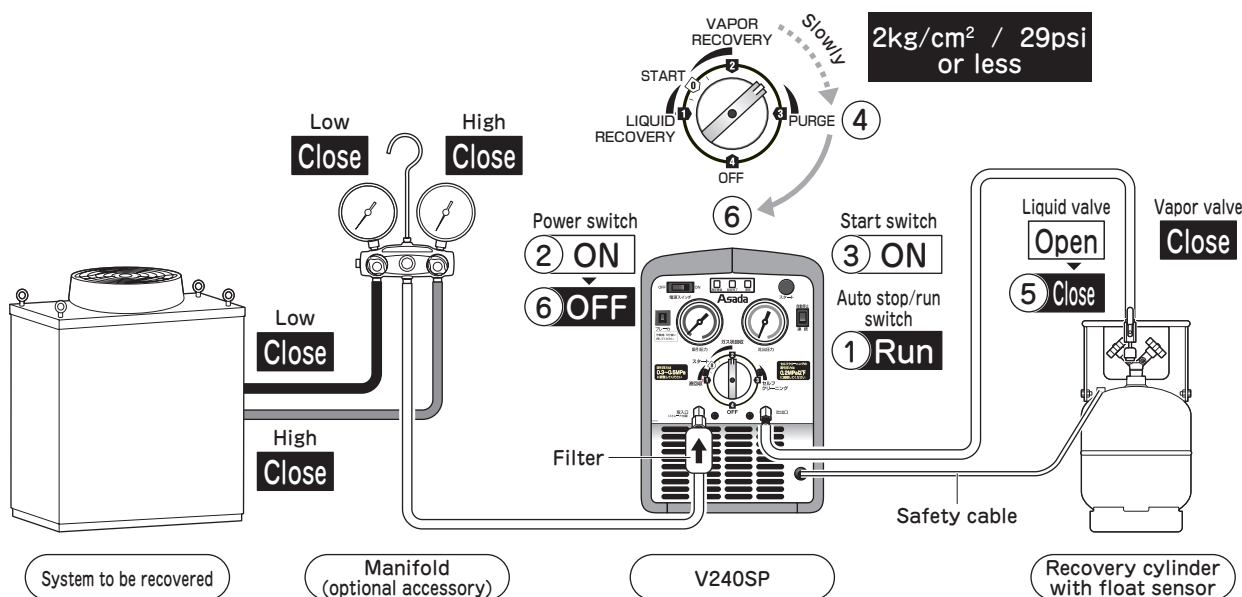

Valve operation

- ① Set the Auto stop/run switch to the "Run" position.
 - ② Set the Power switch to the "ON" position.
 - ③ Push the Start switch.
- * Please refer to "P20 How to Restart the Recovery Machine" if the unit does not run smoothly and restart the unit
- ④ Turn the valve of the recovery machine slowly to the "③ PURGE" position.
- * Adjust suction pressure with valve to under $2\text{kg/cm}^2 / 29\text{psi}$.

Operation

- ⑤ Close Liquid valve of the cylinder immediately after suction pressure to vacuum.
- * For restarting, see "page 20 How to Restart the Recovery Machine" .

End of operation

- ⑥ Set the Power switch to the "OFF" position.

- * There is vapor refrigerant left in the recovery machine and the hose of the discharge side.

Connect the hose of the discharge side to an evacuated cylinder to recover the refrigerant left in the recovery machine and the hose.

- ⑦ Set the valve of the recovery machine to the "④ OFF" .
 - ⑧ Disconnect the hoses.
- * Do not left any refrigerant in the recovery machine.

⚠ CAUTION



- ◆ Wear protective goggles and rubber (leather) gloves.
If refrigerant falls in your eyes or touches your skin, it may lead to sight loss or cold injury.

- ⑨ Put the cap back on the connector of the safety cable on the cylinder.

ECOsaver V240SP

Push/Pull Recovery Procedure

- This method is recommended for recovery from a system which has a large amount of refrigerant (5kg or more).
- Recovery time can be reduced by recovering the liquid refrigerant in the system to the cylinder and then recovering the remaining refrigerant in vapor.
- This method cannot be applied to the following systems.
 - Refrigeration and air-conditioning systems whose refrigerant volume is less than 5kg.
 - Systems which have a heat pump or a solenoid valve.
 - Systems which have an accumulator.
- There are some other cases to which this method cannot be applied. Ask the manufacturer of the system if not clear.

1) Connection of the hoses and cords

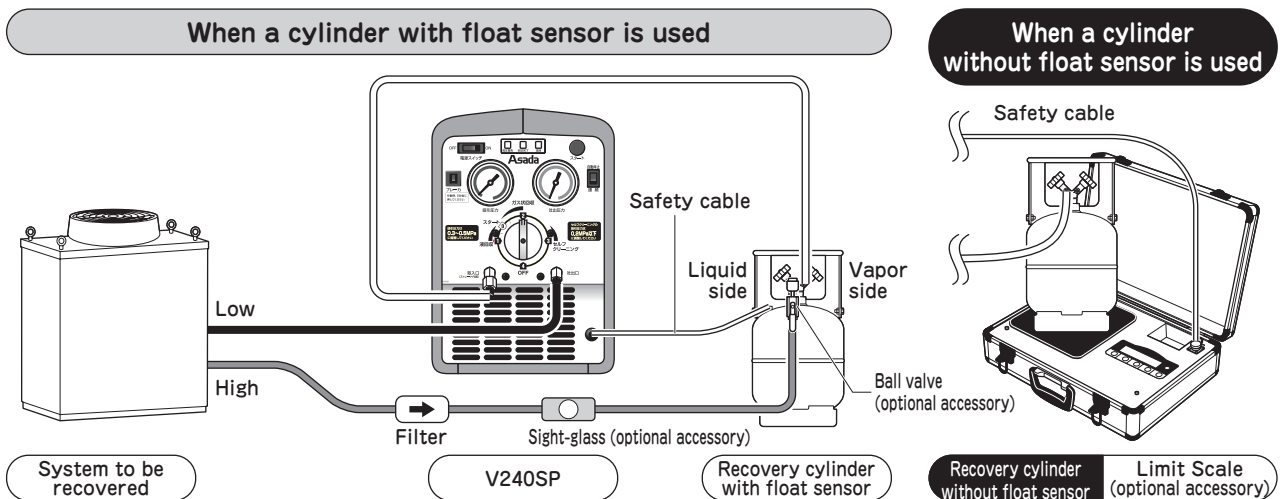

- ① Connect the hoses as above.

⚠ CAUTION



◆ Use our Limit Scale (Code No. LS452,LS152) when a cylinder without float sensor is used.

* Use optional hoses, Sight-glass (ES603) and 1/4" ball valve (Y93843).

- ② Connect the safety cable to the connector on the cylinder or on Limit Scale.

⚠ CAUTION



◆ The recovery machine will not start without connecting the safety cable.

ECOsaver V240SP

2) Evacuation of the air from the recovery machine and the hoses

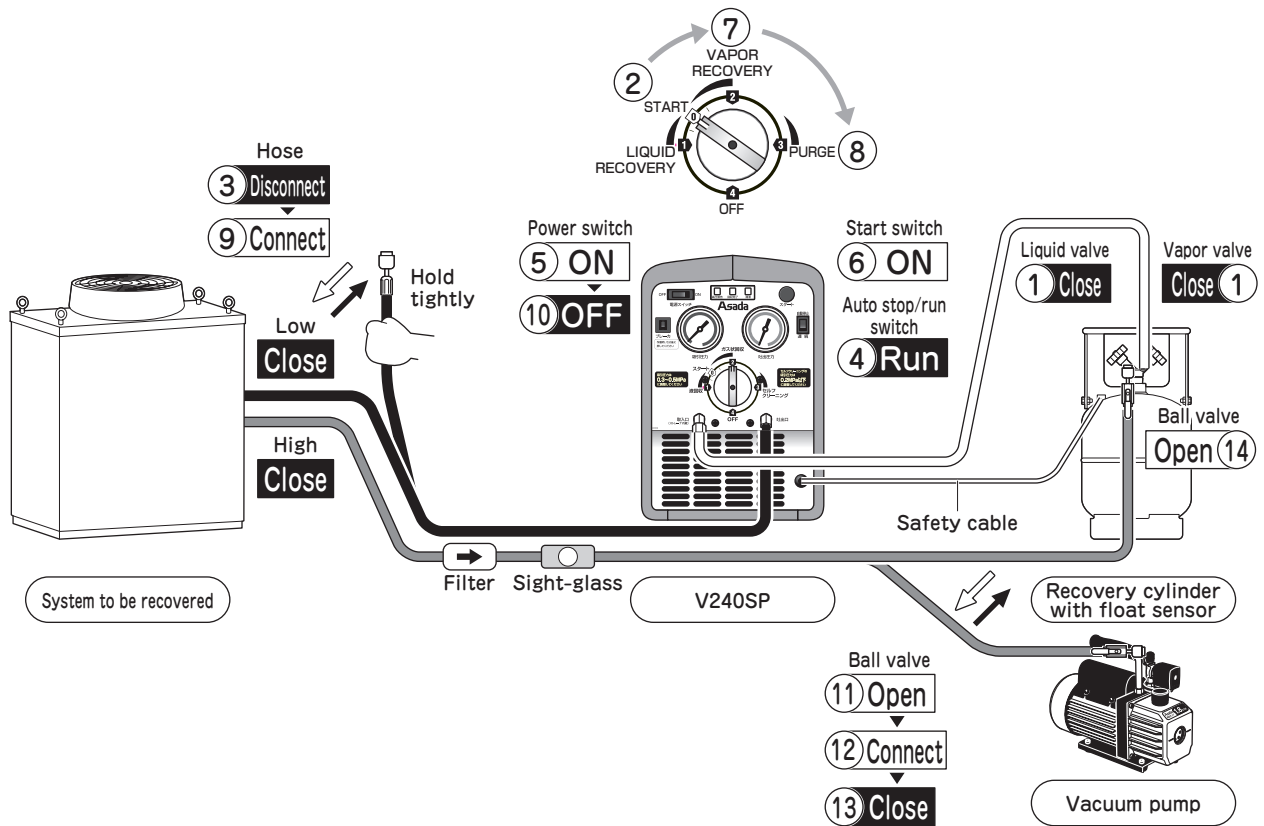

Valve operation

- ① Close the liquid valve and the vapor valve of the cylinder.
 - ② Set the valve of the recovery machine to the "① START" position.
 - ③ Disconnect the hose connected to the low pressure side of the system and open the ball valve.
- * Hold the hose tightly.

Operation

- ④ Set the Auto stop/run switch to the "Run" position.
 - ⑤ Set the Power switch to the "ON" position.
- * Do not set the Auto stop/run switch to the "Auto stop" position.
- Air may be left in the machine.
- * If the "Auto stop" position is selected, the recovery machine will stop automatically.
- Set to the "Run" position to restart.
- ⑥ Push the Start switch.
 - ⑦ Set the valve of the recovery machine to the "② VAPOR RECOVERY" .

- ⑧ When the suction pressure reaches to vacuum, set the valve of the recovery machine to the "③ PURGE" position.
- ⑨ When the suction pressure reaches to vacuum again, connect the hose to the low pressure side of the system.

End of operation

- ⑩ Set the Power switch to the "OFF" position.
- ⑪ Open the ball valve of the hose connected to the cylinder.
- ⑫ Connect the hose to a vacuum pump and evacuate the air from the hose.
- ⑬ Close the ball valve of the hose.
- ⑭ Connect the hose to the liquid port of the cylinder and open the ball valve.

CAUTION



- ◆ Wear protective goggles and rubber (leather) gloves. If refrigerant falls in your eyes or touches your skin, it may lead to sight loss or cold injury.

ECOsaver V240SP

3) Recovery procedure

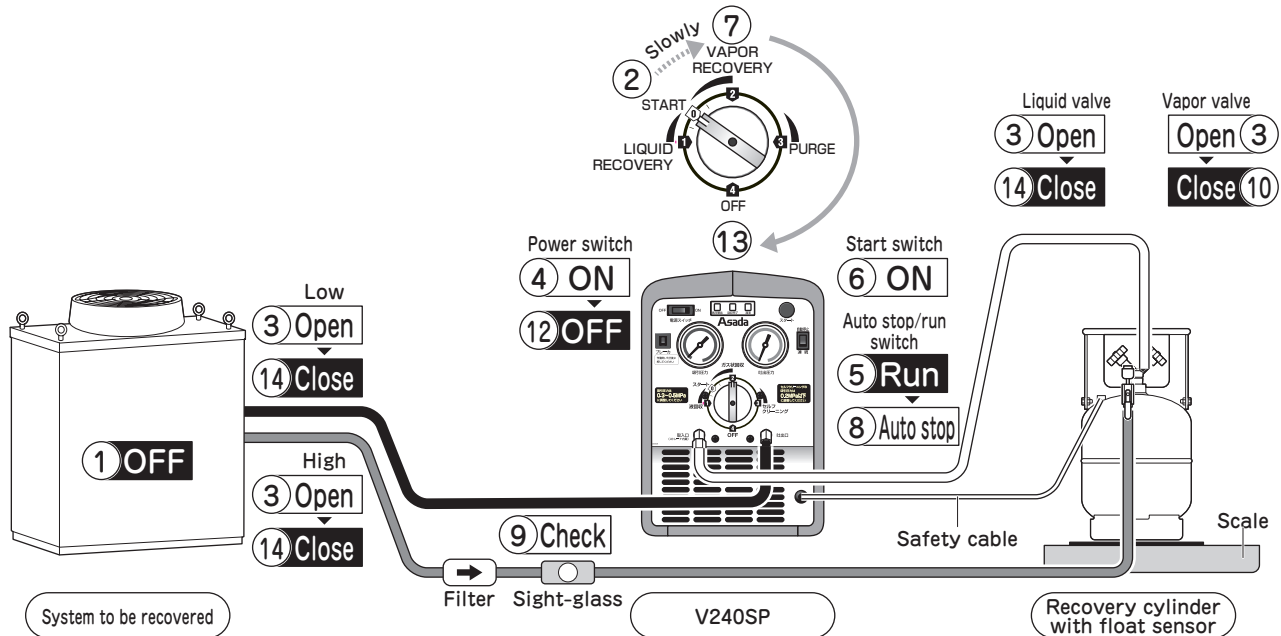

HOW TO USE

Valve operation

- ① Switch off the system to be recovered.
- ② Set the valve of the recovery machine to the "① START" position.
- ③ Open the liquid and the vapor valves of the cylinder and also the low pressure side and the high pressure side valves of the system.

Operation

- ④ Set the Power switch to the "ON" position.
- ⑤ Set the Auto stop/Run switch to the "Run" position.
- ⑥ Push the Start switch.
- ⑦ Turn the valve of the recovery machine slowly to the "② VAPOR RECOVERY" position.
- ⑧ Set the Auto stop/run switch to the "Auto stop" position.
- ⑨ Make sure there is no liquid flow in the sight-glass.

End of operation

- ⑩ Close the vapor valve of the cylinder.
- ⑪ When the suction pressure reaches to $-26\text{cmHg}/-10\text{inHg}$, the Recovery complete lamp is on and the recovery machine stops automatically.
- ⑫ Set the Power switch to the "OFF" position.

- ⑬ Set the valve of the recovery machine to the "④ OFF" position.
- ⑭ Close all valves.
- ⑮ Change the connection of the hoses and perform vapor recovery according to "Liquid/Vapor Recovery Procedure" as there is still some vapor refrigerant left in the system.

CAUTION



- ◆ Wear protective goggles and rubber (leather) gloves.

If refrigerant falls in your eyes or touches your skin, it may lead to sight loss or cold injury.



- ◆ In case of Push/pull recovery, use a scale to check the amount of refrigerant recovered.

When the cylinder is full, refrigerant may be recovered continuously even after the recovery machine stops and may lead to overfilling.

ECOsaver V240SP

Recovery Procedure of R410A or When the Pressure of Refrigerant is High

- Follow the following procedure when R410A or refrigerant at high pressure by heat is recovered. See “Liquid/Vapor Recovery Procedure” for the standard operation.

⚠ CAUTION



- ◆ Noncondensable substance (air) may exist in the cylinder when the temperature of the cylinder rises abnormally during recovery. Remove the air or replace the cylinder.

1) Regulate the suction pressure

- Reduce the suction pressure when R410A is recovered at high ambient temperature.
- The recovery machine may not stop automatically if the suction pressure is 20.4kg/cm² /290psi or more.

In that case, stop the recovery machine manually after confirming that the low pressure gauge indicates 0kg/cm² /0psi or less.

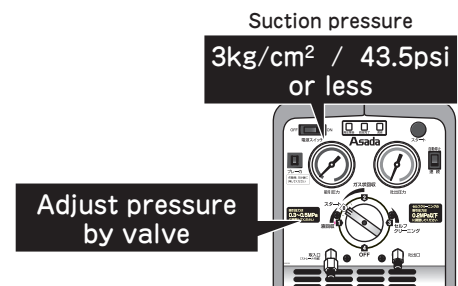

2) Cool down the cylinder (Sub-cooling)

- The following procedure is to cool down (sub-cool) the refrigerant in the cylinder instead of putting the cylinder in water.

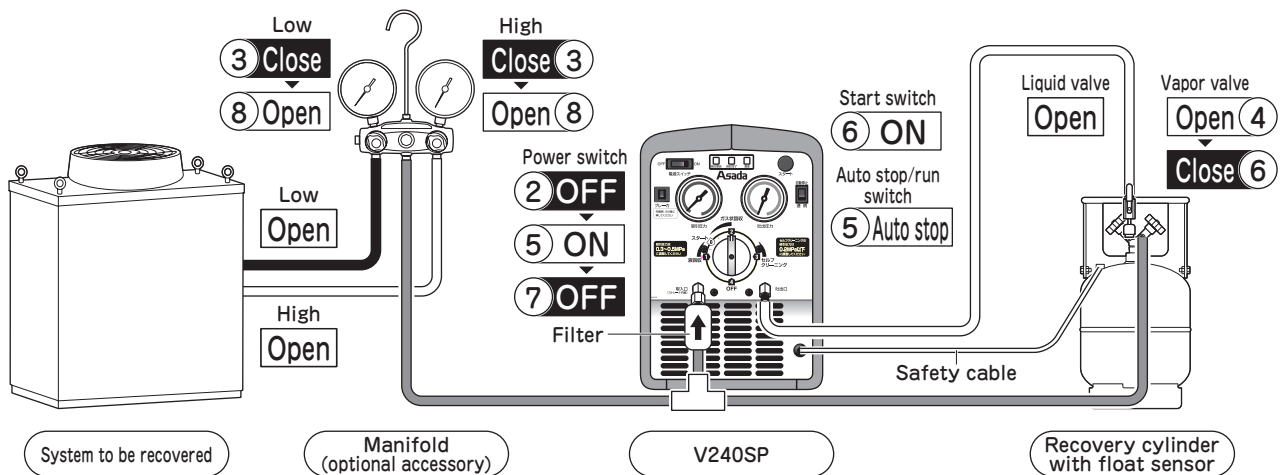

- ① Connect the hoses as above and recover refrigerant.
- ② Set the valve of the recovery machine to the “① START” position when the temperature and the pressure in the cylinder rise.
- ③ Close both the high and the low pressure side valves of the manifold.
- ④ Open the vapor valve of the cylinder.
- ⑤ Turn the valve slowly to the “② VAPOR RECOVERY” position.

* Adjust suction pressure with valve to 3 ~ 5 kg/cm² / 43.5 ~ 72.5psi.

- ⑥ Close the vapor valve of the cylinder when the pressure in the cylinder drops (reduce the discharge pressure by 2kg/cm² /29psi a or more).
- ⑦ Set the valve of the recovery machine to the “① START” .
- ⑧ Open the high pressure side valve or the low pressure side valve of the manifold and continue recovery.

3) Use Cooling Unit CL3 (optional accessory)

- Cooling Unit (Code No. ES801) can lower the temperature of refrigerant at high pressure. It improves the recovery rate up to 20% by cooling refrigerant. See the instruction manual of Cooling Unit for detailed information.

ECOsaver V240SP

How to Restart the Recovery Machine

● The following procedure is effective to restart the recovery machine after temporary stop during operation (when the pressure remains in the machine or when the motor is under load at starting). However if the pressure at discharge side is too high, the unit may not restart. Then cool the recovery cylinder down or replace the cylinder to spare cylinder which is vacuumed.

* The hoses should be connected for liquid (vapor) recovery.
(See p.12)

- ① Close the valves of manifold and system.
- ② Make the valve of the recovery machine about one turn clockwise to set "0 START"
- ③ Turn the valve of recovery machine slowly clockwise twice and set the valve to "0 START" position.
- ④ Set the Power switch to the "ON" position.
- ⑤ Push the Start switch.
- ⑥ If the recovery machine starts, turn the valve of the recovery machine slowly to the "2 VAPOR RECOVERY" or the "1 LIQUID RECOVERY" position.

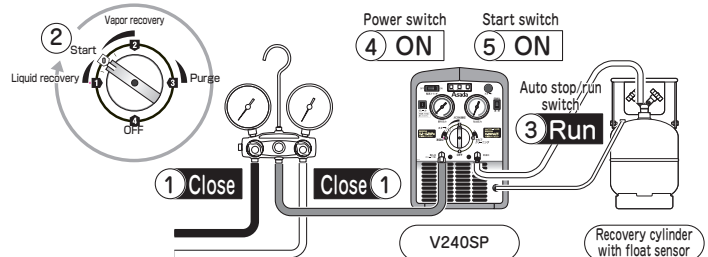

CAUTION



◆ The valve should pass the "3 PURGE" position. Otherwise the pressure cannot be balanced.

How to Recover Different Type of Refrigerant

● Follow this procedure when the different type of refrigerant is recovered.

- ① Connect the discharge port to a vacuum pump with a hose.
- ② Set the valve of the recovery machine to the "3 PURGE" position.
- ③ Switch on the vacuum pump.
- ④ Switch off the vacuum pump after 10 minutes.
- ⑤ Clean the strainer at the suction port if necessary.

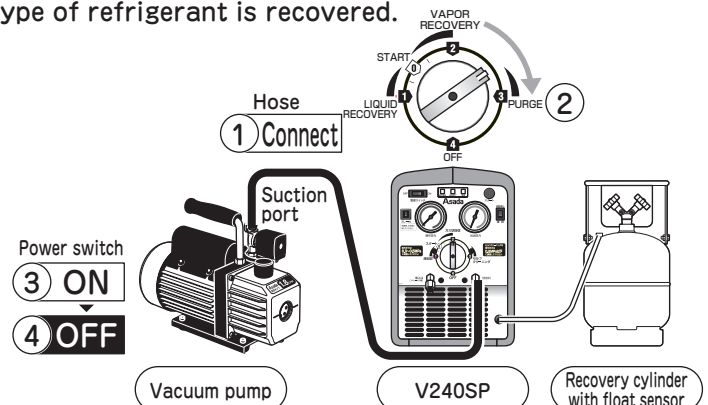

In Case the Machine Stops During Operation

1) When the recovery machine stopped by a circuit breaker (10A).

- ① Set the Power switch of the recovery machine to the "OFF" position and reset the breaker after approximately 5 minutes.
- ② Restart the recovery machine according to "How to Restart the Recovery Machine" .

2) When the recovery machine stopped by a thermal protector.

- ① The recovery machine may not start when the temperature of the motor is too high.
- ② Leave the recovery machine for 10 to 20 minutes as the protector will be reset when the motor is cooled down.

3) When the High pressure warning lamp was on and the recovery machine stopped.

- ① Set the Power switch to the "OFF" position.
- ② Remove the causes of the high pressure.
(Cool down the cylinder by ice and so on when the pressure in the cylinder exceeds 35.7kg/cm² /507.5psi. Or replace the cylinder with another one.)
- ③ Restart the recovery machine according to "How to Restart the Recovery Machine" .

4) When the Recovery complete switch is on and the recovery machine will not restart.

- ① Restart the recovery machine according to "How to Restart the Recovery Machine" .

ECOsaver V240SP

RECOVERY CYLINDER

Risk of overfilling

- Refrigerant is a high pressure gas and mistakes in use or handling will lead to a serious accident.

1) Relation between the temperature and the pressure of refrigerant in a cylinder

The pressure of the refrigerant varies depending on the ambient temperature when the refrigerant is filled in a cylinder.



At this time, lowering of the liquid level by evaporation and rising of the liquid level by specific volume increase occur at the same time and balance.



At this time, rising of the liquid level by liquefaction and lowering of the liquid level by specific volume decrease occur at the same time and balance.

The right graph shows the relation between the pressure (saturation pressure) and the temperature (saturation temperature) for each kind of refrigerant.

This relation between the saturation pressure and the saturation temperature is found when both liquid and vapor exist in a cylinder. Normally the inside of the cylinder is under this condition and this chart is useful for field operation.

When a cylinder is almost full with liquid and no vapor, the pressure rises rapidly even with a slight increase in temperature.

This phenomenon must be avoided in any circumstances.

Saturation pressure and saturation temperature of each type of refrigerant

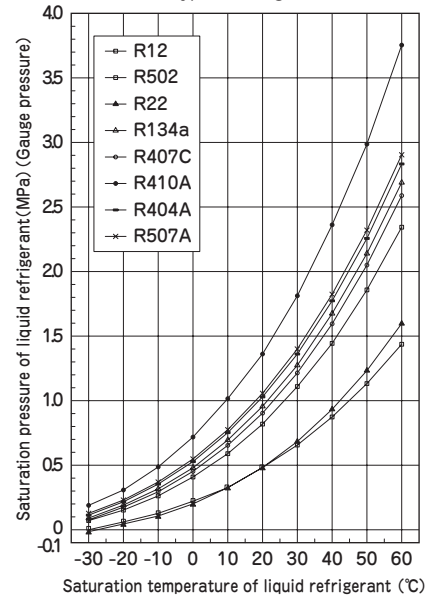

Temperature and pressure of refrigerant in cylinder

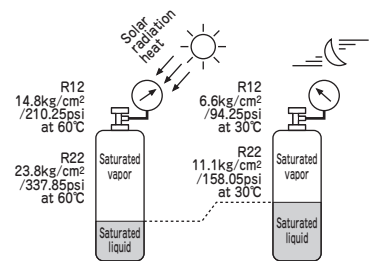

ECOsaver V240SP

MAINTENANCE & INSPECTION

- Inspect and clean regularly as instructed below and perform correction or replacement timely.

Check the cords

- ① Make sure the power plug and the power cord have no damage.
- ② Connect the Safety cable to the float sensor on the cylinder.
- ③ Set the Auto stop/run switch to the "Run" position.
- ④ Set the Power switch to the "ON" position.
- ⑤ Push the Start switch.
- ⑥ Make sure the recovery machine starts.
- ⑦ Make sure the Tank full lamp is on and the recovery machine stops when the Safety cable is disconnected.

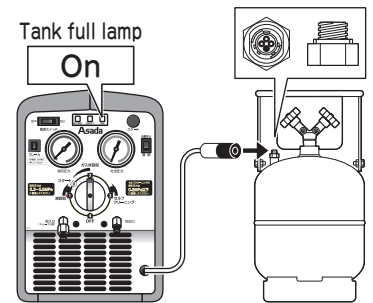

Check refrigerant leak

- ① Make sure there is no leak from the machine, the hoses and so on.

Check the overfilling prevention function (in case a cylinder with float sensor is used)

- ① Connect the Safety cable to the float sensor on the cylinder.
- ② Set the Auto stop/run switch to the "Run" position.
- ③ Set the Power switch to the "ON" position.
- ④ Push the Start switch.
- ⑤ Make sure the recovery machine starts.
- ⑥ Make sure the Tank full lamp is on and the recovery machine stops when the cylinder is turned upside down.

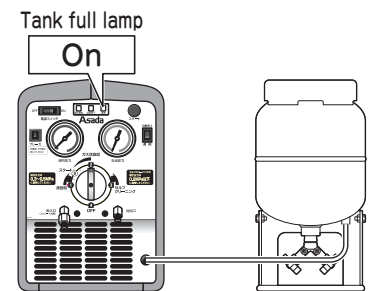

Check the overfilling prevention function (in case a cylinder without float sensor is used)

- ① Connect the Safety cable to the connector on the Limit Scale.
- ② Set the Auto stop/run switch to the "Run" position.
- ③ Set the Power switch to the "ON" position.
- ④ Push the Start switch.
- ⑤ Make sure the Tank full lamp is on and the recovery machine stops when the cylinder is pushed by hand to give the weight which is enough to operate the overfilling function.

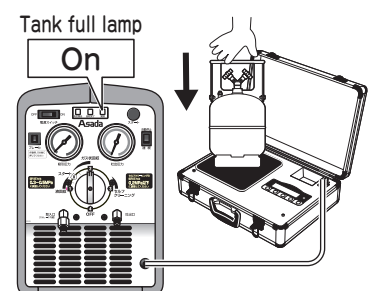

Cleaning • replacement of the built-in strainer

- ① Remove the strainer holder on the suction port by using a wrench.
- ② Check the strainer and clean it with water or thinner if clogged or dirty.
- ③ Dry it well before installing.
* If damaged, replace it with a new one.

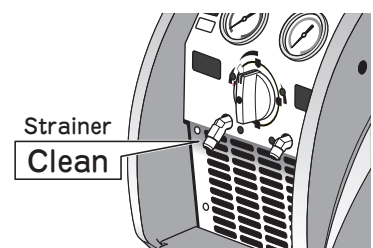

ECOsaver V240SP

Check the recovery function

- ① Set the valve of the recovery machine to the “② VAPOR RECOVERY” position.
- ② Set the Auto stop/run switch to the “Run” position.
- ③ Set the Power switch to the “ON” position.
- ④ Push the Start switch.
- ⑤ Make sure the air is sucked from the suction port and discharged from the discharge port.
- ⑥ Set the valve of the recovery machine to the “④ OFF” position and make sure the suction pressure reaches the vacuum area.

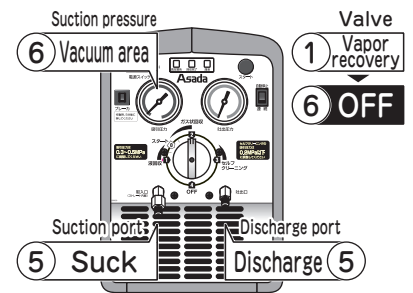

Check the purge function

- ① Set the valve of the recovery machine to the “③ PURGE” position.
- ② Set the Auto stop/run switch to the “Run” position.
- ③ Set the Power switch to the “ON” position.
- ④ Push the Start switch.
- ⑤ Make sure the suction pressure reaches the vacuum area and the air will not be discharged from the discharge port.

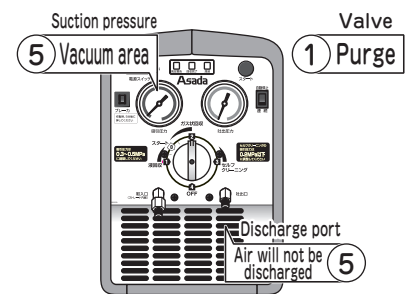

Check the high pressure warning function

- ① Connect a hose with ball valve to the discharge port of the recovery machine and close the ball valve.
- ② Set the valve to the “② VAPOR RECOVERY” position.
- ③ Set the Auto stop/run switch to the “Run” position.
- ④ Set the Power switch to the “ON” position.
- ⑤ Push the Start switch.
- ⑥ Make sure the recovery machine is stopped by the high pressure switch and the High pressure warning lamp is on after a while.

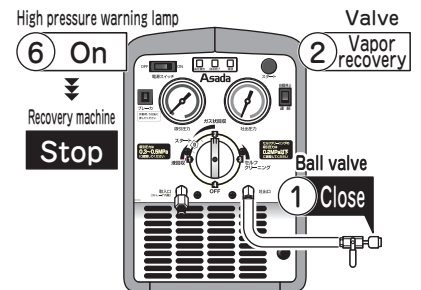

Check the low pressure cut-off function

- ① Set the valve to the “④ OFF” position during the recovery machine is stopped by the high pressure switch.
- ② Open the ball valve of the discharge port.
- ③ Set the Auto stop/run switch to the “Auto stop” position.
- ④ Set the Power switch to the “ON” position.
- ⑤ Push the Start switch.
- ⑥ Make sure the recovery machine stops automatically when the suction pressure reaches the vacuum area and the Recovery complete lamp is on.

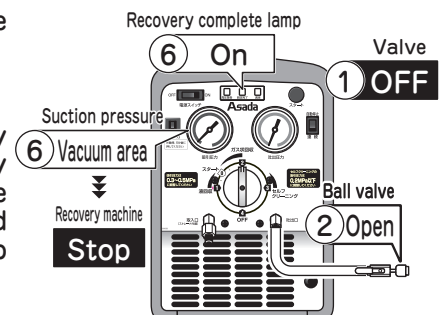

ECOsaver V240SP

BEFORE REQUESTING REPAIR OR SERVICES

Symptom	Cause	Solution
The machine will not start.	① The power cord is not plugged in.	① Plug in the power cord.
	② The safety cable is not connected.	② Connect the safety cable.
	③ The suction side is in vacuum or the low pressure switch is faulty.	③ Make the suction side to positive pressure. Replace the low pressure switch.
	④ The machine is in high pressure shut off.	④ Reduce the pressure in the high pressure line.
	⑤ The breaker tripped. (the lamp of the power switch is not on.)	⑤ Set the power switch to the "OFF" position and set it again to the "ON" position after a while.
	⑥ The thermal protector operated due to overheating of the motor.	⑥ Wait until the motor cools down.
	⑦ The cylinder is full.	⑦ Replace the cylinder.
	⑧ The float sensor of the cylinder is faulty.	⑧ Repair
	⑨ The motor was burned.	⑨ Repair
	⑩ The compressor is locked.	⑩ Repair
	⑪ Wiring disconnection	⑪ Repair
	⑫ The high pressure switch is faulty.	⑫ Repair
The machine stops soon after starting.	① The liquid valve of the cylinder is closed.	① Open the liquid valve of the cylinder.
	② The pressure in the cylinder is high.	② Cool down the cylinder or use Cooling Unit.
	③ The hose has a core depressor.	③ Remove the core depressor of the hose.
	④ The ball valve of the hose is closed.	④ Open the ball valve of the hose.
The recovery speed is slow or the machine will not recover.	① The built-in strainer is clogged.	① Clean or replace the built-in strainer.
	② The pressure in the cylinder is high.	② Cool down the cylinder.
	③ The piston seal is worn out.	③ Repair
	④ The cylinder valve is damaged.	④ Repair
	⑤ The hose has a core depressor.	⑤ Remove the core depressor in the hose.
	⑥ The refrigerant in the system is frozen.	⑥ Perform liquid recovery after melting.
The suction pressure is extremely low.	① The connecting part or the hose of the suction side is clogged.	① Remove the cause of clogging (replace the hose gasket).
	② The strainer is clogged.	② Clean or replace the strainer.
	③ The manifold valve of the suction side is throttle back on the flow too much.	③ Regulate the valve again.
The discharge pressure is extremely high.	① The liquid valve of the cylinder or the discharge valve of the recovery machine is closed.	① Open the valve completely.
	② The cylinder has air inside.	② Release the air from the vapor port little by little until the saturated temperature conforms to the saturated pressure.
	③ Air enters from the suction side (the nut is loose).	③ Tighten the connection at the suction side.
	④ The temperature (inside pressure) of the cylinder is high.	④ Cool down the cylinder or replace the cylinder.
	⑤ The pressure gauge is faulty.	⑤ Repair
Refrigerant leaks from the recovery machine.	① The safety valve opened.	① Close the valves of the suction and discharge ports of the recovery machine and wait until the pressure drops.
	② Loose flare connection or damage of the copper tubes.	② Repair
Abnormal noise from the compressor	① Liquid slugging	① Throttle the valve of the suction side.
	② Oil slugging	② Install an oil separator between the system and the recovery machine.
	③ The compressor is damaged.	③ Repair

ECOsaver V240SP

ELECTRIC WIRING DIAGRAM

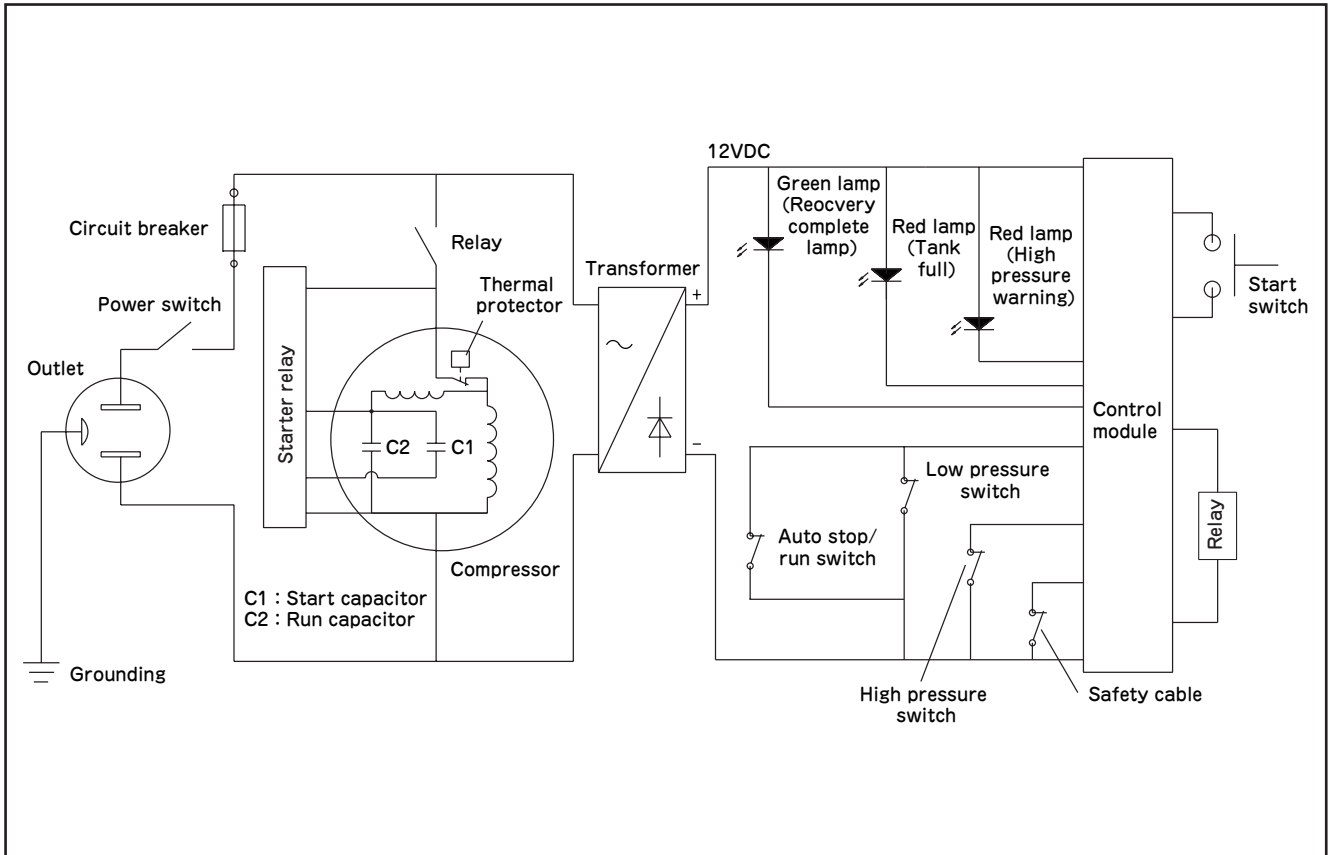

ECOsaver V240SP

FLOW DIAGRAM

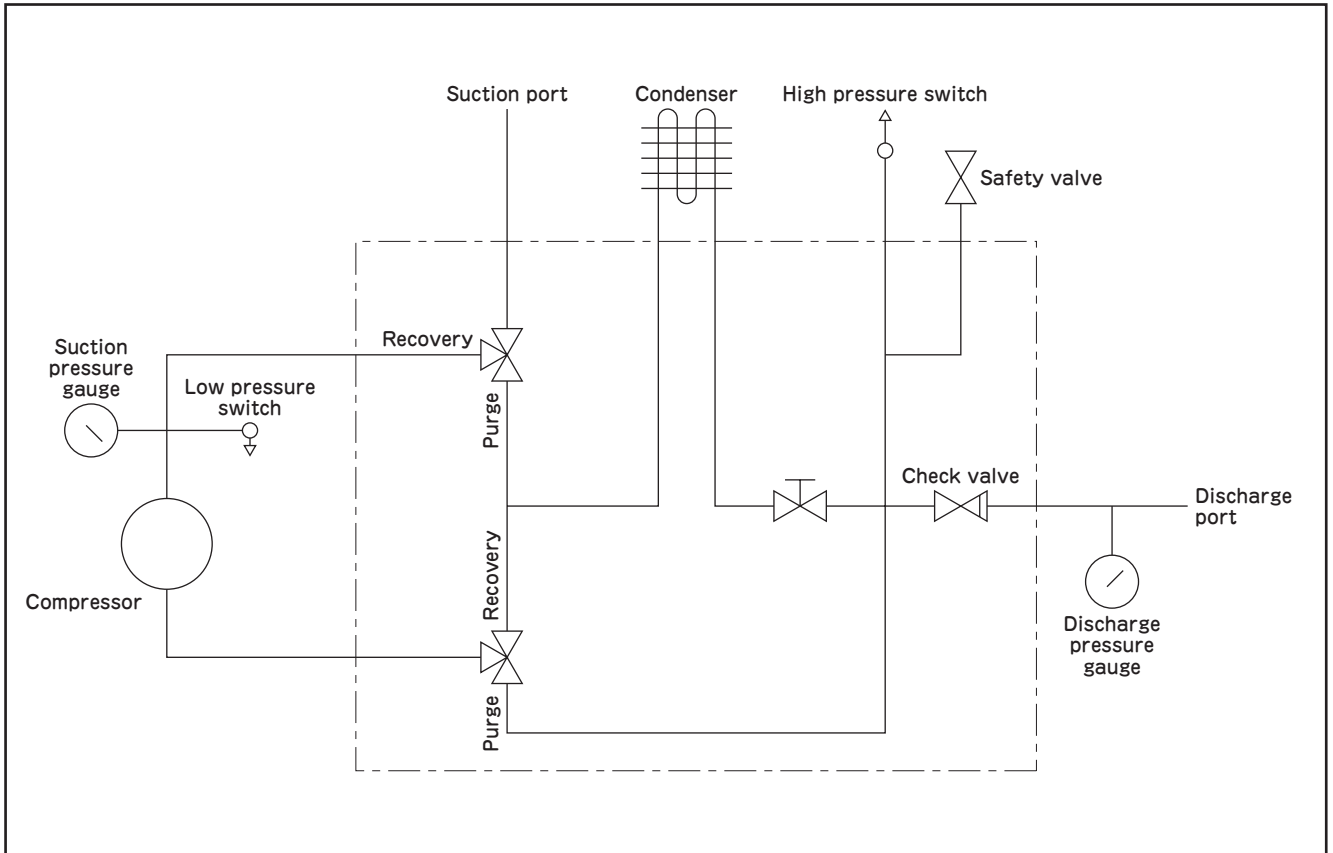

●Customer Memo Please fill in for your record in the future
The information is helpful for inquiry and ordering parts.

Products Number:

Date Purchased:

Store Purchased the Unit:

Asada
ASADA CORPORATION

3-60, Kamiida, Nishi-Machi, Kita-Ku, Nagoya, Japan 462-8551

TEL +81-52-914-1062

FAX +81-52-914-1065

URL <http://www.asada.co.jp>

E-mail: trade@asada.co.jp