

Asada

Recovery and Reclaim machine

ECOcycle Aurora II

INSTRUCTION MANUAL

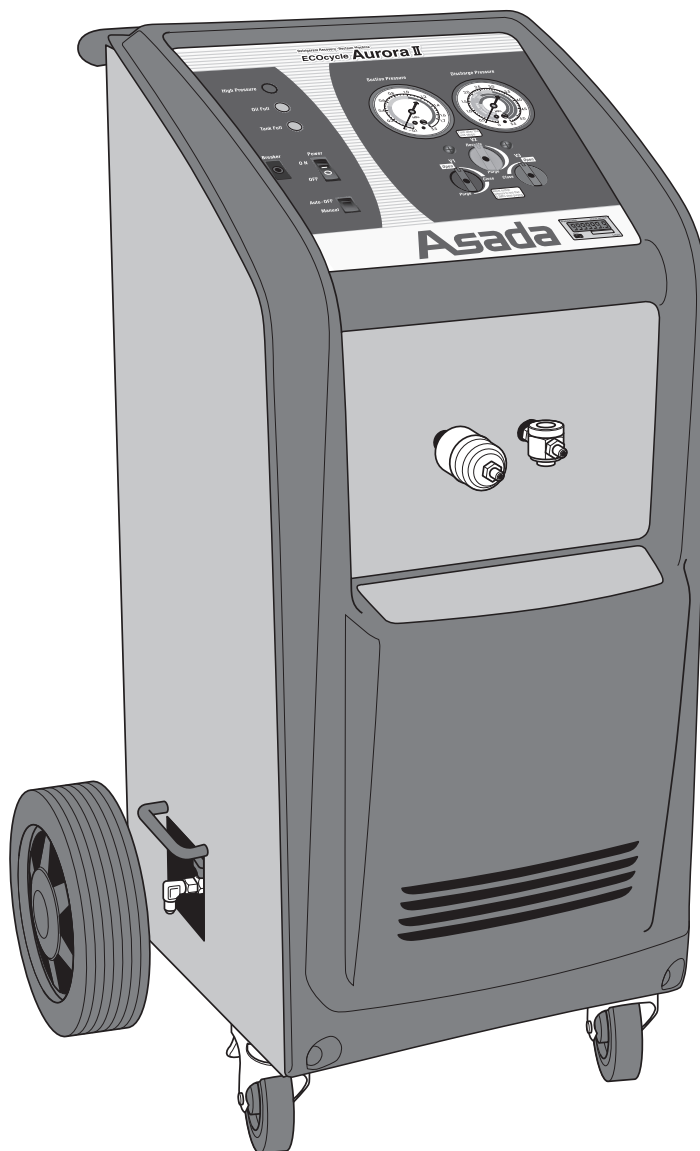

【Please read this manual before operation】

ECOcycle Aurora II

FOR SAFE OPERATION

Thank you for selecting Recovery and Reclaim machine Eco Cycle Aurora II .



- Please give this operation manual to anyone who operates this unit.
- For safe and efficient operation any operator should read this manual thoroughly before operation.
- Keep this manual at a safe place that is easily accessible by operators.
- Do not use this unit for purposes other than originally intended.
- Check the following as soon the unit is delivered:
 - Is the specification same as the ordered product?
 - Has there been any damage or deformation during delivery?
 - Are any accessories missing?

















If you have any questions, please contact the store where you have purchased this unit or our sales department.

(The contents of this manual may be changed without prior notice.)

CATEGORIES OF WARNING SIGNS

The warning signs used in this manual or on the product are divided in the following two categories.

 WARNING	Situation that may cause death or serious injury to the operator or anyone in the immediate area.
 CAUTION	Situation that may cause minor to medium injury to the operator or anyone in the immediate area or may cause damage to the unit.

 Deadly Poison	 Caution for Gas	 Explosion	 Fire	 No Fire	 Electric Shock
 Burn	 Rotating	 Wear Protective Gear	 Do Not Disassemble	 Grounding	 Power Source Voltage
 Handling of Wire	 Working Condition	 Others	 Operation Manual		

INDEX

WARNING FOR SAFETY	2	Discharge Oil Method (Electrostatic Filter)	16
COMPONENTS OF THE UNIT	5	Warm Up Operation	17
Name of Each Part	5	How to Purge Non Condensable Gases	18
Specification	6	RECOVERY CYLINDER	19
Standard Accessories	6	MAINTENANCE & INSPECTION	20
Optional Accessories (Recovery Cylinder)	7	Maintenance	20
Optional Accessories (Other Air-Conditioning Equipment)	7	Replace Molecular Sieve Pack	20
HOW TO USE	8	In Case of Reclaim Other Refrigerant.....	21
Preparation Before Operation	8	VARIOUS INSPECTION METHODS	21
Precautions regarding peripheral devices used	9	BEFORE REQUESTING REPAIR OR SERVICES	23
Recovery / Reclaim Operation.....	9	ELECTRIC WIRING DIAGRAM	24
Discharge Oil Method (Oil separator)	16	FLOW DIAGRAM	25

ECOcycle Aurora II

WARNING FOR SAFETY

- General warnings in operating this unit are mentioned in this section.
- While specific details are mentioned in each particular clause.

⚠ WARNING



- ◆ **When performing reclaim operation, choose a location that has good ventilation. In enclosed areas, mechanical ventilation should provide at least four air changes per hour or the unit should be used at least 0.5m above the floor.**

Leakage of gas without sufficient ventilation may cause suffocation due to lack of oxygen.



- ◆ **Do not reclaim flammable gas (hydrocarbon or hydrocarbon material). If anything other than fluorocarbon [Ammonia, hydrocarbon (propane, isobutene, etc.)] gets into the unit, it may cause an explosion.**



- ◆ **Burning refrigerant produces toxic and strongly acidic gas, which is extremely dangerous if inhaled.**

There should be absolutely no flammable material near the working area and the unit must be operated under good ventilation.



- ◆ **Absolutely no smoking or any open flame during the work in process.**

Cigarettes may create Strong acid gas and cause a fire.

- ◆ **Use safety glasses and leather hand gloves during operation or when disconnecting hoses.**

Refrigerant gas may cause frostbite or damage your eye sight.



- ◆ **Do not close the valves of the unit and the hoses when they are full of liquid refrigerant.**

- ◆ **Do not operate or store the unit at temperature above 35°C.**

When the reclaim operation is done, operate the purge procedure to prevent the liquid refrigerant from expanding which may cause an explosion.



- ◆ **Use a scale to monitor the amount of refrigerant in the cylinder.**

Stop filling at 80% or less as the cylinder may explode in the event of full filling.

- ◆ **Use ONLY authorized refillable refrigerant cylinders. The unit requires the use of recycle cylinders with a minimum working pressure of 2.76 MPa (400 psi).**

Do not exceed the working pressure of the recycle cylinder.

- ◆ **Do not operate the unit with wet hands or in the rain.**

Handling the electric plug and power switch with wet hands or in the rain, may cause electric shock.



- ◆ **Make sure to have the unit grounded (earthed).**

If the unit is not properly grounded, it may cause electric shock.



- ◆ **Check the electric power plug regularly to make sure of no damage.**









Always have the plug inserted firmly.









When the plug has dirt or oil or the connection is incomplete, it may cause electric shock or fire.

ECOcycle Aurora II

⚠ WARNING

-  ◆ **Do not have the electric cord connected to other electrical devices or with other cords.**
It may cause fire.
-  ◆ **Do not pull on the electric power cord to remove from the outlet.**
It may cause fire or injury.
-  ◆ **The power source should be AC220-240V 10A or use a generator with the capacity of 3KVA or more.**
If the capacity of the generator is not large enough, it may lead to overheating, smoking or fire. See the specification label or this manual for the detailed specifications.
-  ◆ **Do not set up the unit in a location where gasoline, thinner, or flammable gas exists.**
The reclaim unit sparks at the start-up time and may ignite gasoline and thinner. If leaked gasoline or flammable gas accumulates at near the unit, it may cause explosion and fire.
-  ◆ **Always turn off the switch and pull out the power cord during inspection and maintenance.**
The unit may suddenly start and cause accident.
-  ◆ **Do not disassemble. The unit should only be repaired by an authorized repair person.**
-  ◆ **Do not operate the unit with the cover removed.**
It may cause injury or damage.
-  ◆ **Various safety devices are built into this unit. Always carry out pre-start inspection according to page 21 "VARIOUS INSPECTION METHODS" before using.**
If any abnormality is found in the unit, please stop using it immediately and contact your dealer or our sales representative.
-  ◆ **This appliance should be used in locations with mechanical ventilation that provides at least four air changes per hour or the appliance should be used at least 0.5 m above the floor.**

⚠ CAUTION

-  ◆ **Transport carefully.**
The unit may get damaged and this may also cause injury.
-  ◆ **When moving the unit, push it with the handle. Do not pull the unit.**
-  ◆ **Install Filter at Suction Port.**
Otherwise the compressor may be damaged.
-  ◆ **Any extension cord should be a three-core cable with at least 2.0mm² diameter if 20 m or less or 3.5 mm diameter if 20 to 30 m long.**
An unsuitable extension cord (too thin or too long) may lead to failure or fire, or electrical components may be damaged.
-  ◆ **If the cord used is a two-core cord without a ground wire, it may cause an electric shock.**
-  ◆ **Do not reclaim refrigerant which contains sealant.**
Sealant may clog the valves or the check valves.

ECOcycle Aurora II

⚠ CAUTION



- ◆ **Keep a space of 1m or more around the unit.**
Do not let other workers come within 1m of the unit.



- ◆ **Do not let visitors touch the unit.**

- ◆ **Do not use the unit for purposes other than the originally intended.**
This unit is designed to reclaim the specified refrigerants.



- ◆ **Do not operate the unit with overload.**
Operating under overload may cause an accident or damage to the unit.

- ◆ **Do not use the unit on an uneven floor.**
The unit or the cylinder may fall over and lead to an accident.

- ◆ **The operating platform and the work area should be kept neat, clean and well-lit to avoid accidents.**

- ◆ **Do not operate the unit when fatigued or under the influence of alcohol or medications.**

- ◆ **When the reclaim unit is not in use, store in a dry space and out of reach by children.**



- ◆ **Do not use accessories other than those referenced in this manual or shown in our catalogue. Use of other accessories may cause problems.**

- ◆ **If the reclaim unit is dropped or struck, inspect immediately for damage.**
Reclaim under damaged, cracked and dented condition may cause injury.

- ◆ **Check daily for deformed or corroded parts.**



- ◆ **If an abnormal condition (strange smell, vibration, strange noise) is noticed, stop operation immediately and refer to page 23 in the manual "BEFORE REQUESTING REPAIR OR SERVICE".**



- ◆ **Request repair or service instead of disassembling the unit. Contact the store where the unit was purchased.**

- ◆ **Use our cylinders that are expressly made for recycling.**

- ◆ **Use cylinders that match the type of refrigerant being reclaimed.**

- ◆ **Disposal (For EU countries only)**

Components of the unit are recyclable material and should be put to recycling. For this purpose registered and certified recycling companies are available. For an environmental friendly disposal of the non-recyclable parts (e.g. electronic waste) contact your local waste disposal authority.



Do not dispose electric tools with domestic waste. In accordance with the European Directive 2012/19/EC the disposal of electrical and electronic equipment and its implementation as national law, electric tools that are no longer serviceable must be collected separately and utilized for environmentally compatible recycling.

- ◆ **The hour meter contains a CR Coin Cell Lithium Battery.**

For details on how to remove the battery, please contact your dealer or supplier for details.



If you wish to discard these Batteries, please contact your local authorities or dealer and ask for the correct method of disposal.

- ◆ **When disposing the unit :**

Handle according to the regulations or the method defined by each municipality.
(Molecular Sieve, Filter, various plastic parts, etc.)

ECOcycle Aurora II

COMPONENTS OF THE UNIT

Name of Each Part

Labels are required by law for safety and the warnings are placed on the reclaim unit. If the label comes off the unit or became dirty and unreadable, request us for new label. Replace the label at the same position on the unit.

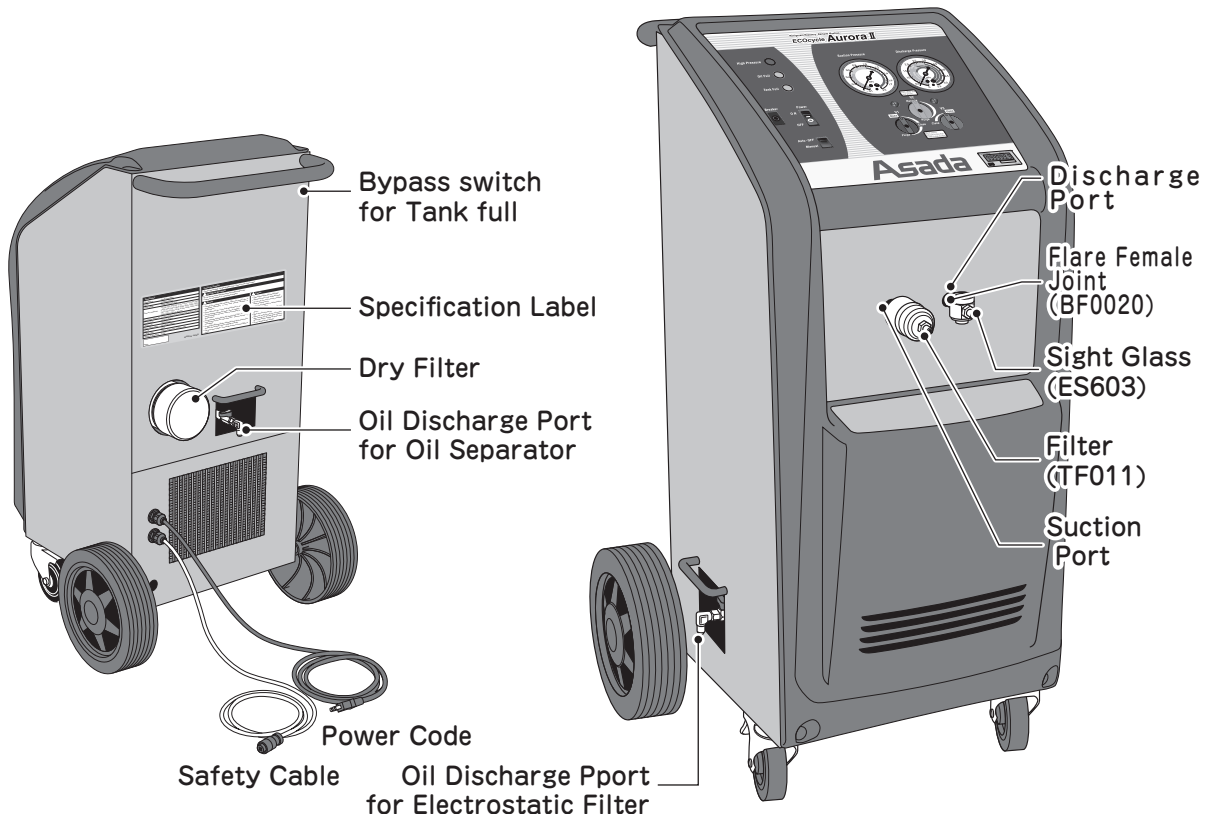
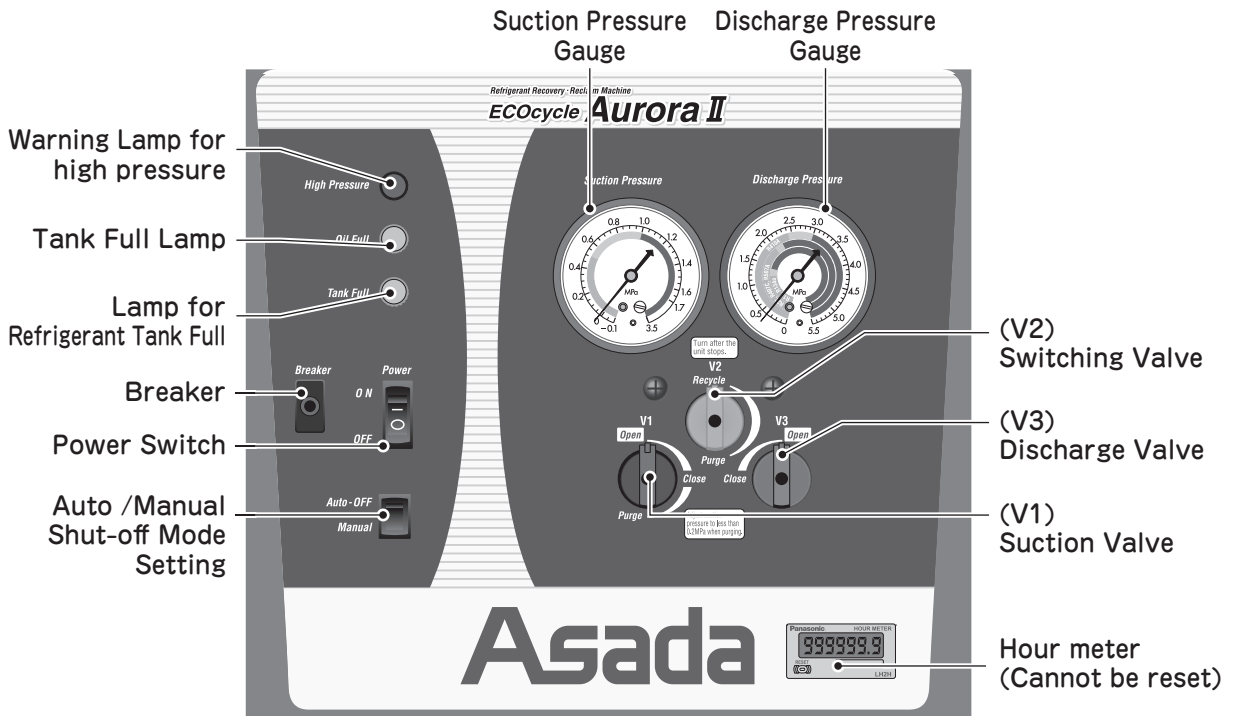

ECOcycle Aurora II

Specification

COMPONENTS OF THE UNIT

Description	Eco Cycle Aurora II		
Code No.	AR023A		
Recovery refrigerant	R12, R22, R32, R500, R502, R115, R125, R218, R134a, R401A, R401B, R402A, R402B, R403B, R404A, R407A, R407B, R407C, R407D, R407E, R410A, R410B, R422A, R422D, R507A, R509A, R1234yf		
Reclaimable refrigerant	R12, R22, R32, R500, R502, R134a, R404A, R410A, R507A, R509A, R1234yf		
Recovery method	Liquid recovery method (possible to vapor recovery)		
Reclaim method	Electric statistic separation reclaim method		
Power supply	220V-240V (50 / 60Hz) recommending 10A over		
Compressor	750W (1HP) Oil less		
Dimension(L x W x H)	UNIT : 562 x 538 x 976mm	Packing : 760 x 623 x 1,198mm	
Weight	UNIT : 60kg	Packing : 92kg	
Electric consumption	587/622W (50/60Hz)		
Electric current of operation Electric current of starting	8.9/6.0A (50/60Hz) · 34A		
Operating temperature	5 - 35°C		
Applicable cylinder (over fill protection method)	Float sensor type : Recovery cylinder (with float sensor) 6L · 12L · 24L · 40L · 120L		
	Weighing type : Recovery cylinder (without float sensor) with "Digital scale with overfill prevention device" 12L · 21L · 24L · 120L		

Recovery / Reclaim rate	R22	R410A	R32	R134a
Liquid (g/min)	220	220	100	100
Vapor (g/min)	90	90	90	90

- * Specifications are subject to change without prior notice.
- * Recovery / Reclaim rates vary under different conditions.
- * When reclaim R134a, R12, R1234yf follow page 13 in the operation manual.

Reclaim capacity	R22	R410A	R32	R134a
Moisture (ppm)	< 5	< 7	< 7	< 7
Acid (ppm)	< 0.1	< 0.1	< 0.1	< 0.1
Total residue on evaporation (%)	< 0.005	< 0.005	< 0.005	< 0.005
Non condensable gas (%)	< 0.5	< 0.5	< 0.5	< 0.5

- * Results of the reclaim varies depending on the contamination of the refrigerant to be reclaim.

Standard Accessories

Description	Code No.
1/4" Charging hose Plus II with ball valve (Red) 152cm	Y29660
1/4" Charging hose Plus II with ball valve (Blue) 152cm	Y29260
Filter	TF011
Filter Core E	AR179E
Instruction Manual	IM0345A
Manual for operation	IM0346A
Sight Glass	ES603
Flare female joint	BF0020
Machine Cover	AR199

ECOcycle Aurora II

Optional Accessories (Recovery Cylinder)

Description	Capacity	Port	Code No.
Refrigerant cylinder for Recovery · Reclaim (with float sensor)	1L	1/4" flare	TF040
	6L		TF090
	12L		TF056
	24L		TF057
	40L	1/4" flare	TF130
		3/8" flare	TF131
	120L	1/4" flare	TF110
		3/8" flare	TF129
		1/2" flare	TF097
		3/4" flare	TF098

Description	Capacity	Port	Code No.
Refrigerant cylinder for Recovery · Reclaim (without float sensor)	24L	1/4" flare	TF080
	120L		TF070

* "Digital scale with overfill prevention device" must be used when recovery cylinders (without float sensor) are used.

* Our original recovery cylinder should be used.

Optional Accessories (Other Air-Conditioning Equipment)

Name of Item	Code No.	Explanation of the Item
AR molecular sieve pack	AR222	Replacement molecular sieve for inside of Molecular sieve pack.
Charge faster SF	WA6625SF	It is always used by connecting it to the intake (standard accessory), and it is also used when collecting and recycling R134a, R12 and R1234yf (optional accessories).
Filter	TF011	Used when collecting and recycling R134a, R12 and R1234yf (optional accessories).
Vacuum Pump	Various Type	High efficient 2-stage vacuum pump with a check valve.
Cooling unit CL3 (3/8") (*) 100V MODEL ONLY	ES801	Improves the efficiency of recovery in summer climate, recovery in a large volume or recovery of R410A and R32 by using together with this unit.
Header (with Ball Valve)	TF039	Recovery of up to 6 units at the same time.
1/4" Quick joint with vacuum gauge	Y02005A	Checks depth of vacuum in the system being recovered to judge completion of recovery.
Sight Glass 1/4 Male x Male	ES603	Visually check refrigerant flow either in vapor or liquid.
Adapter for different diameter for auto A/C (quick type) 3/16" female x 1/4" male	Y19120	Adapter to connect to the small service port (3/16") for R12.
High pressure quick joint for R134a (M12)	Y03100M	For quick connection to the service port (high pressure side) for R134a.
Low pressure quick joint for R134a (M10)	Y03200M	For quick connection to the service port (low pressure side) for R134a.
1/4" Ball Valve	Y93843	Prevent release of refrigerant when Disconnecting hose.
Quick charging valve A	Y18975	Can be used without leaking refrigerant. Recovery speed improves without Schrader.
Charging hose plus II with SealRight fitting	Various sizes available	Low loss anti-blow back SealRight fitting traps refrigerant in the hose when disconnected.
Charging hose plus II for R410A		Charging hose for R410A.
Charging hose plus II with ball valve for R410A		Charging hose with ball valve for R410A.
Charging hose plus II for R134a		Charging hose for R134a.

ECOcycle Aurora II

HOW TO USE

Preparation Before Operation

1) Discharge nitrogen gas from the unit

* A new unit is filled with nitrogen gas at atmospheric pressure to prevent damage during transit. If pressure gauge is over 0 MPa (0 psi), do the following procedures:

- ① Connect the unit to proper power supply.
- ② Connect Filter to Suction Port.
(Refer to page 10 ③)
- ③ Connect Sight Glass to Discharge Port.
- ④ Open V1 Suction Valve and V3 Discharge Valve.

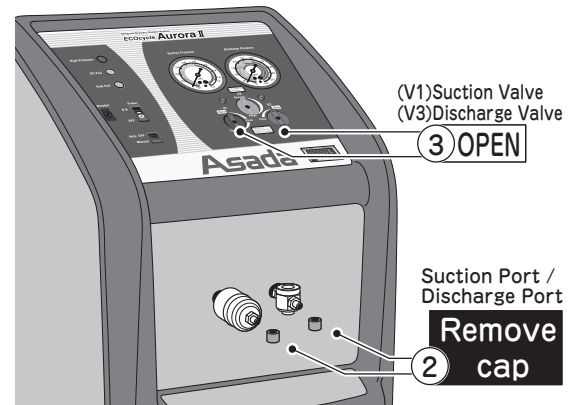

2) Installation of the unit

Install the unit according to the following.

- ① Flat space indoors.
- ② Lock front wheels properly.
- ③ Keep 1m or more around the unit for safe operation.

3) Preparation of Cylinder

⚠ CAUTION



- ◆ Brand-new cylinders have nitrogen inside. Evacuation should be done after discharging nitrogen by opening the vapor valve.
- ◆ Do not evacuate cylinders which contain refrigerant. The refrigerant will be discharged to the air and the vacuum pump oil will blow out.

Evacuate a cylinder by using a vacuum pump (optional accessories).

- ① Connect the suction port of the vacuum pump to the vapor port of the cylinder with a hose.
- ② Switch on the vacuum pump.
- ③ Close the liquid port of the cylinder and open the vapor port.
- ④ Close the vapor port of the cylinder when the vacuum reaches -0.095 MPa (-13.8 psi) \sim -0.1 MPa (-14.5 psi).
- ⑤ Switch off the vacuum pump.
- ⑥ Disconnect the hose between the vacuum pump and the cylinder.

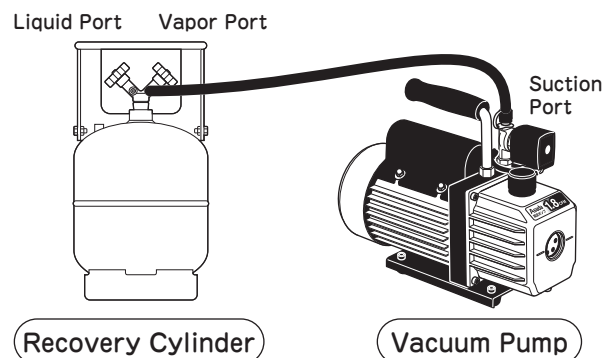

4) Precautions

- ① In case ambient temperature is under 10°C , the unit needs warming up before operation. Refer to the page 17, Warm Up Operation. Do not operate at temperature under 5°C and over 35°C .
- ② Filter provided as standard accessory must be installed on Suction Port when operating the unit.
- ③ Do not reclaim following refrigerant with the unit :
 - Refrigerant charged in a system which the compressor has been burned out.
 - Refrigerant which may be mixed with other type of refrigerant.
 - Refrigerant which contains sealant.

ECOcycle Aurora II

Precautions regarding peripheral devices used

- (1) Be sure to use our product or a product approved by us for the recovery cylinder. It is dangerous to use the recovery cylinder that is not approved by us, as it may cause a rupture.
- (2) When using peripheral accessory other than our company (manifold, charging hose, cooling unit, oil separator, etc.), the working pressure must be 3.0 MPa (435 psi) or more or pressure resistance is 4.5 MPa (650 psi) or more.
- (3) Be sure to use the accessory of the recovery unit from the manufacturer of the recovery unit. Using self-made devices is dangerous because it may not be possible to ensure the prescribed safety.
- (4) Be sure to follow the contents of each instruction manual for connection and operation to each device. Connections or operations other than those described in the instruction manual may cause not only the specified performance but also danger.

Recovery / Reclaim Operation

Following steps must be taken:

- 1) Connection of hose and cords
- 2) Evacuation of the unit and hoses
- 3) Recovery / Reclaim Procedure
- 4) Refrigerant discharge (purge) Procedure

1) Connection of hose and cords

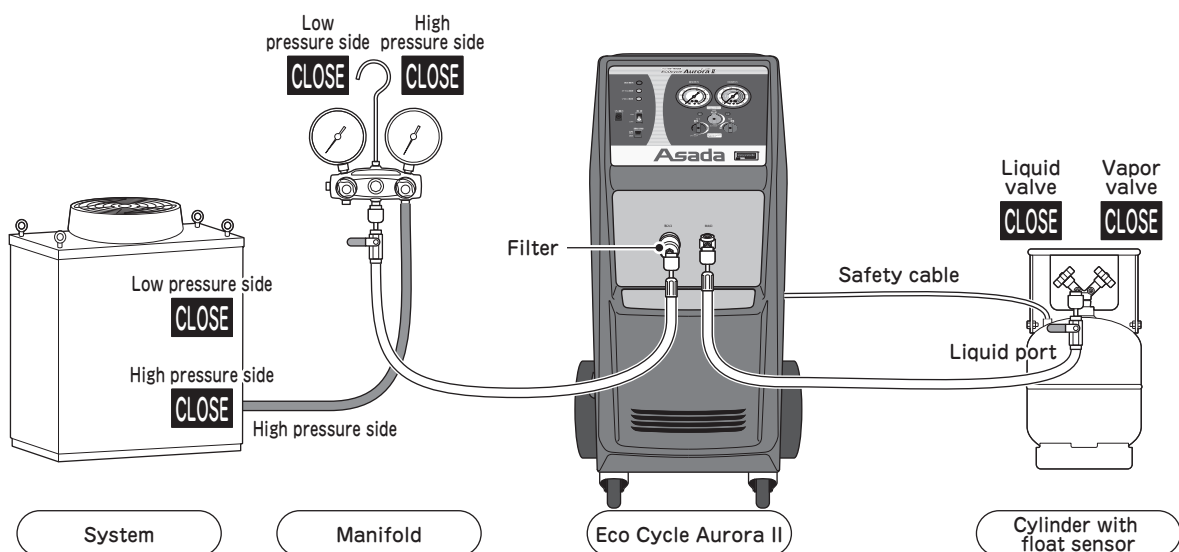

- ① Connect the hoses as above.

⚠ CAUTION



- ◆ Be sure to use a scale to prevent overfilling of cylinder.
- ◆ Use ONLY authorized refillable refrigerant cylinders. This unit requires the use of recovery cylinders with a minimum working pressure of 2.76 MPa (400 psi).

ECOcycle Aurora II

- ② Connect the safety cable to the connector on the cylinder or on Digital scale with overfill prevention device.

⚠ CAUTION



- ◆ The unit will not start without connecting the safety cable.

- ③ Connect Filter to Suction Port of the unit. (Code No.TF011)

⚠ CAUTION



- ◆ Make sure the installing direction.
- ◆ Hold Suction Port firmly with a wrench to prevent damage of inside parts when connecting Filter.
- ◆ When you replace the AR molecular sieve or if it becomes clogged, replace the filter.



- ④ Open and install AR179E Filter Core E provided as a standard accessory. (Refer to page 20)

⚠ CAUTION



- ◆ This installation should be done quickly after open the package to avoid spoiling the quality of Molecular Sieve.

- This unit is equipped with an "hour meter" to know when to replace the AR moisture adsorbent.
- In addition to grasping the replacement time, please use it for various management by the customer.
- When using the hour meter as a guide for the replacement time, replace it when the following time has elapsed, depending on the type of refrigerant.

R134a/R1234yf : About 40 hours
Refrigerants other than the above: About 20 hours

- The hour meter cannot be reset.

As a guide for the replacement time after the second time, judge by the time added to the display time at the time of replacement.

- ⑤ When recovery / reclime R134a, R12, and R1234yf, connect Charge Faster SF (optional accessories : Code No.WA6625SF) and filter (optional accessories : Code No.TF011) on the manifold.

ECOcycle Aurora II

2) Evacuation of the unit and the hoses

- * Make sure there is no refrigerant in the unit before starting. (check on Gauges). If refrigerant inside, first follow purge procedure.
- * If the unit does not start by switching on, the low pressure switch may be activated. In that case, the low pressure switch can be released by applying a higher pressure than atmospheric pressure.

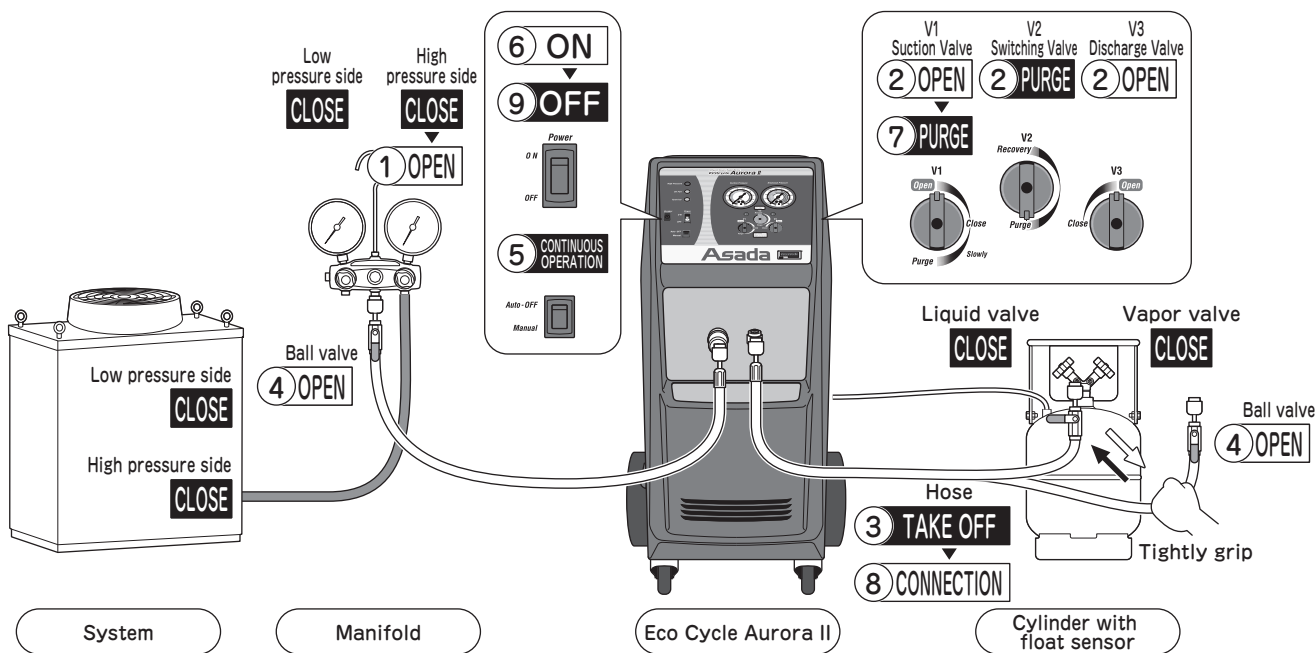

- ① [OPEN] high pressure side valve of manifold.
- ② [OPEN] V1 Suction valve.
[PURGE] V2 Switching valve.
[OPEN] V3 Discharge valve.
- ③ [Disconnect] the hose which is connected to the liquid port of the cylinder.
- * Hold the hose tightly.
- ④ [OPEN] the ball valve of the hose.
- ⑤ Set the Auto OFF/Manual switch to the [Manual] position.
- ⑥ Set the Power switch to the [ON] position.
- ⑦ When the suction pressure reaches vacuum, set the V1 Suction valve of the unit to the [Purge] position.
- ⑧ [Connect] hose (③) to liquid side of cylinder after the suction pressure gauge was reach vacuum again.
- ⑨ Set the Power switch to the [OFF] position.

ECOcycle Aurora II

3) Recovery / Reclaim Procedure

⚠ CAUTION



- ◆ Warm up the unit when operating lower than temperature of 10°C .
Refer to page 17 “Warming Up Operation”
- ◆ Connect the Charge Faster SF(Optional accessory: Code No. WA6625SF) and Filter(Optional accessory: Code No. TF011) to manifold's port when recovering R134a and R12, R1234yf and warm up the unit.
Refer to page 13 “Recovery/reclaim method in recovering R134a and R12, R1234yf”

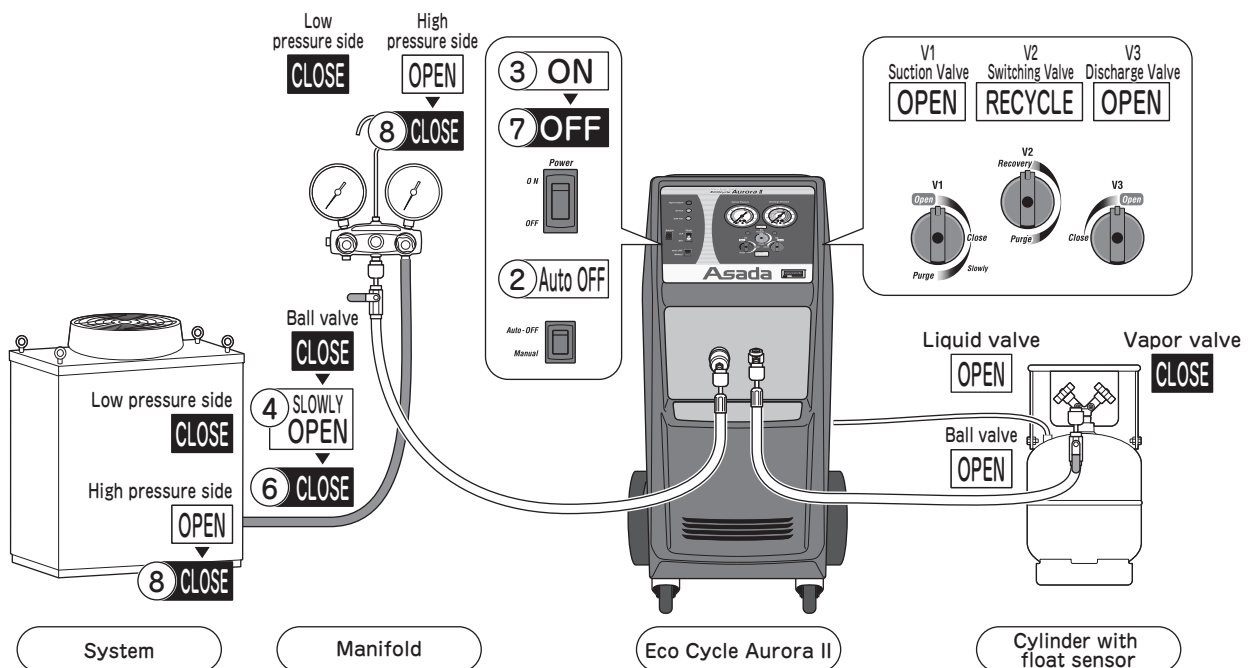

- ① Set each valve as above.
- ② Set the Auto OFF/Manual switch to the [Auto OFF] position.
- * **When using the Auto Shut-off mode, Suction Pressure must be higher than atmospheric pressure for operation.**
- ③ Set the Power switch to the [ON] position.
- ④ Slowly [OPEN] the ball valve of suction hose.
- ⑤ The unit automatically stops when the suction pressure becomes -0.03MPa (-4.4 psi).
- ⑥ [CLOSE] the ball valve of suction hose.
- ⑦ Set the Power switch to the [OFF] position.
- ⑧ [CLOSE] high pressure side of Manifold and system.

After the recovery operation, leave the system for 5 to 10 minutes to see if the refrigerant mixed in the refrigeration oil will evaporate.
If the pressure rises from the set value, repeat the recovery operation.

Refrigerant value	Set value
less than 2kg	0 MPa (0 psi)
2kg or more	- 0.01 MPa (- 1.4 psi)

ECOcycle Aurora II

Recovery / Reclaim method in recovering R134a and R12, R1234yf

- When recycling R134a and R12, R1234yf, liquid refrigerant will collect in the oil separator unless the regenerating work is performed by the following method.
- If the recycling work is continued, the tank full lamp will light up and the unit will stop.

■ Prepare the following accessories in advance. (Optional accessories)

(A) Code No. WA6625SF	Charge faster SF	1 piece
(B) Code No. TF011	Filter	1 piece

- Connect Charge Faster SF (A) to the center port of the manifold, and connect the Filter (B) to the high pressure side port of the manifold.

■ Warm up

- Warm up the unit every time regardless of temperature. (Refer to page 17 "Warm Up Operation".)
- If the pressure of the reclaimed R134a, R12, R1234yf is low (if the temperature is low), warm the R134a, R12, R1234yf in the cylinder with a heater to increase the pressure.

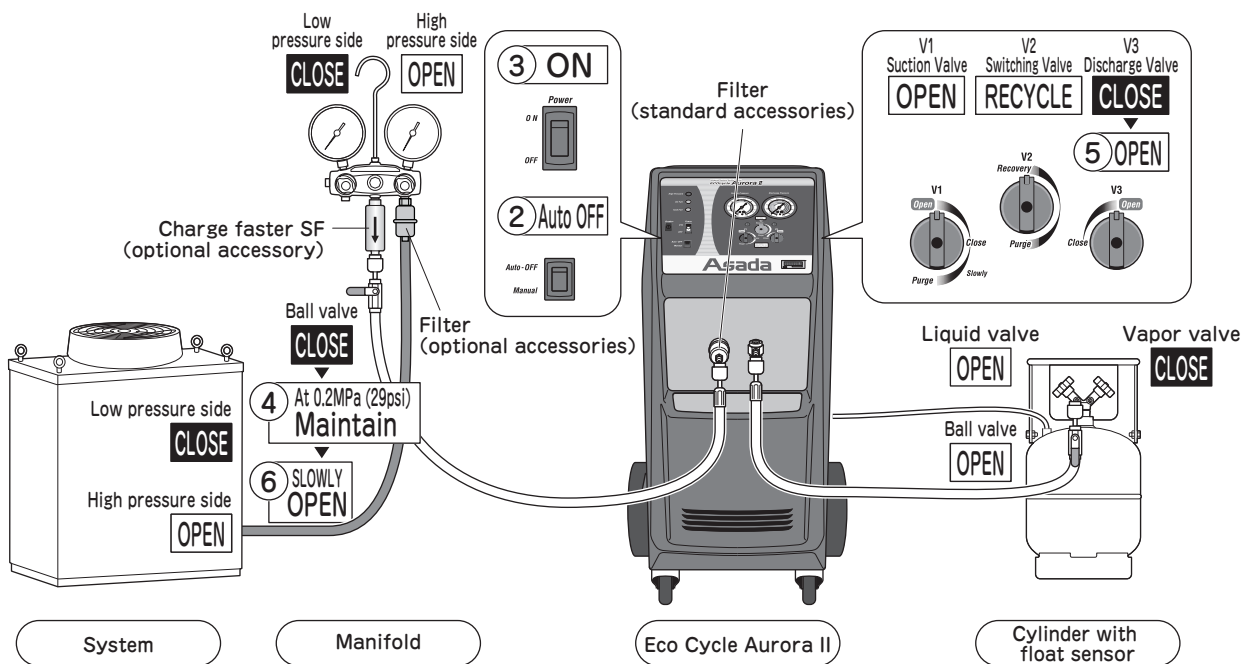

- ① Connect hoses as above after carry out Page11 "2) Evacuation of the unit and the hoses"
- ② Set the Auto OFF/Manual switch to the [Auto OFF] position.
- ③ Set the Power switch to the [ON] position.
- ④ As opening the ball valve of the suction hose, adjust suction pressure to around 0.2MPa (29 psi) , keep operating for 5 to 7 minutes.
[In case of R134a, R12, R1234yf, the suction pressure until become 1.0 MPa (145 psi)]
- ⑤ After operating for 5 to 7 minutes, [OPEN] V3 Discharge valve.
- ⑥ Slowly open the ball valve of the suction hose which almost opened with taking 20 seconds.
- ⑦ Follow ordinal Recovery/ Reclaim Procedure.

ECOcycle Aurora II

■ Note (CAUTION)

(*) When reclaim R134a, R12, R1234yf perform it in an environment of 10 degrees or more as much as possible.

(1) R134a, R12 R1234yf has a high boiling point and is harder to gasify than R410A.

Avoid working in a low temperature environment as much as possible.

(2) Even if the normal reclaiming procedure is performed after a warm-up operation, if the oil tank full sensor stops the procedure, reduce Suction Pressure to less than 0.2 MPa (29 psi) to prevent R134a, R12, R1234yf from accumulating.

(3) If the surface of Filter connected to the manifold becomes frozen during reclaiming and it stops reclaiming, replace Filter and then restart reclaiming:

Recovery Procedure of R410A, R32 or When the Pressure of Refrigerant is High

- Follow the following procedure when R410A, R32 or refrigerant at high pressure by heat is reclaimed. See "Recovery / Reclaim Procedure" for the standard operation.
- Use the following procedure when refrigerant which becomes high pressure due to temperature rise. Refer to page 12 "Recovery / Reclaim Procedure".

▲ CAUTION



- ◆ Noncondensable substance (air) may exist in the cylinder when the temperature of the cylinder rises abnormally during recovery.
Remove the air or replace the cylinder.
- ◆ The method of removing air is refer to Page18 "How to Purge Non condensable Gases"
- ◆ Warm up the unit when ambient temperature is under 10°C .
Refer to page 17 "Warm Up Operation"
- ◆ It is necessary to use a cylinder with a float sensor to prevent overfilling the cylinder.
- ◆ This unit requires the use of recovery cylinders with a minimum working pressure of 2.76 MPa (400 psi).

■ Use Cooling Unit CL3 (optional accessory) (*) 100V model only

- Cooling Unit (Code No. ES801) can lower the temperature of refrigerant at high pressure by approximately 5 to 10°C .
It improves the recovery rate.
See the instruction manual of Cooling Unit for detailed information.

■ Replacement of spare cylinder

- Even if the cylinder is not full, if the inside pressure of the cylinder is high (When "Warning Lamp for high pressure" lights up and the unit stops.), replace it with an evacuated spare cylinder.
- The high pressure switch operates at 2.9 MPa (425 psi) and returns at 2.4 MPa (350 psi).
- When the Discharge Hose ball valve and the cylinder valve are opened after the cylinder is replaced, the "Warning Lamp for high pressure" goes off and the high pressure switch is reset, and the unit will automatically restart.

ECOcycle Aurora II

4) Refrigerant Discharge (Purge) Procedure

⚠ CAUTION

⚠ ◆ Adjust suction pressure less than 0.2 MPa (29 psi) on purging.
This may cause of damaging compressor.

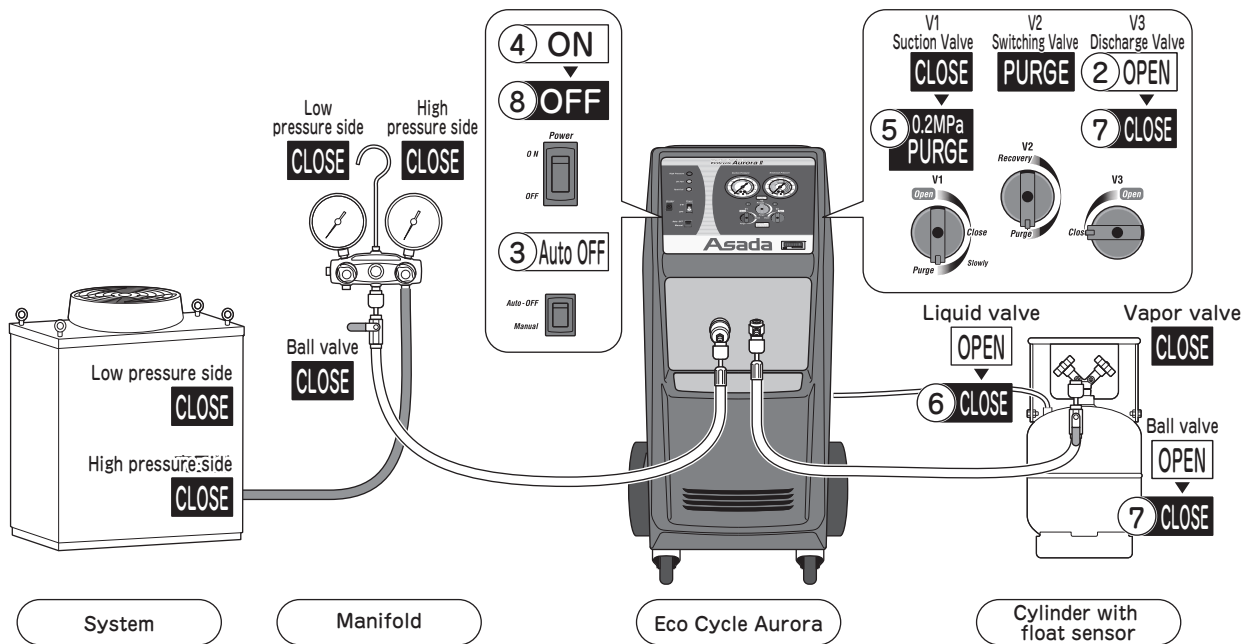

- ① Setting up as the above drawing.
- ② Turn V2 Switching valve to [PURGE] position.
 - * Do not turn the valve during operation or Discharge Pressure Gauge may be damaged.
- ③ Set the Auto OFF/Manual switch to the [Auto OFF] position.
 - * When using the Auto Shut-off mode, the unit does not starts when Suction Pressure is lower than atmospheric pressure.
- ④ Set the Power switch to the [ON] position.
- ⑤ Turn V1 Suction valve slowly to [PURGE] position adjusting Suction Pressure to less than 0.2MPa (29 psi).
- ⑥ [CLOSE] the liquid port of the cylinder when the unit stops automatically.
- ⑦ Turn V3 Discharge valve to [CLOSE] position and close the discharge hose ball valve.
- ⑧ Set the Power switch to the [OFF] position.
- ⑨ [Disconnect] the hoses.
 - * Vapor refrigerant remains in the recovery / reclaim unit and the hose of the discharge side. Connect the hose of the discharge side to an evacuated cylinder to recover all refrigerant in the recovery / reclaim unit and the hose.

⚠ CAUTION

⚠ ◆ Use safety glasses and leather hand gloves when operating or disconnecting hoses. If refrigerant gas touches your skin or gets into your eyes, it may cause frostbite or damage your eye sight.

ECOcycle Aurora II

Discharge Oil Method (Oil Separator)

Discharge the oil when Tank Full Lamp is on (①~⑧) or after daily operation (⑤~⑧).

- ① [Close] the suction hose ball valve from the manifold.
- ② In Auto Shut-off mode, start the unit by pushing Tank Full Bypass Switch.
- * The switch will release unless you keep it depressed.
- ③ The unit stops automatically when Suction Pressure reaches -0.03 MPa (-4.4 psi).
- ④ Set Power Switch to [OFF] position.
- ⑤ Adjust Suction Pressure between 0.1 MPa (14.5 psi) ~ 0.2 MPa (29 psi) by opening the suction hose ball valve from the manifold.
- ⑥ [Remove] the cap of Oil Discharge Port on the back of the unit.
- ⑦ [Open] the valve slowly and discharge the oil into another container.
- * The oil tank capacity is 2L.
- ⑧ [Close] the valve and cap of Oil Discharge Port after discharging the oil.

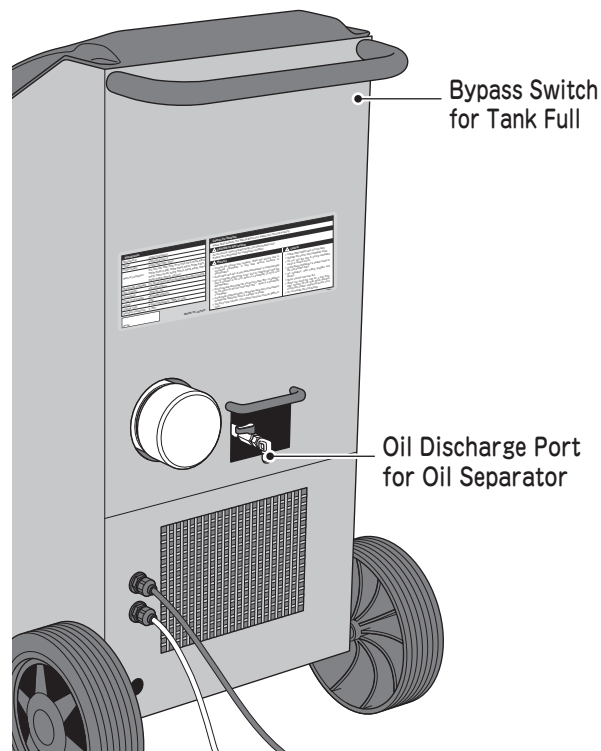

Discharge Oil Method (Electrostatic Filter)

Check every 100 hours of operation for any oil or contamination in the Electrostatic Filter.

- ① Adjust Suction Pressure between 0.1 MPa (14.5 psi) ~ 0.2 MPa (29 psi) by opening the suction hose ball valve from the manifold.
- ② [Remove] cap of Oil Discharge Port.
- ③ [Open] the valve slowly and discharge the oil into another container.
- ④ [Close] the valve and cap of Oil Discharge Port after discharging the oil.

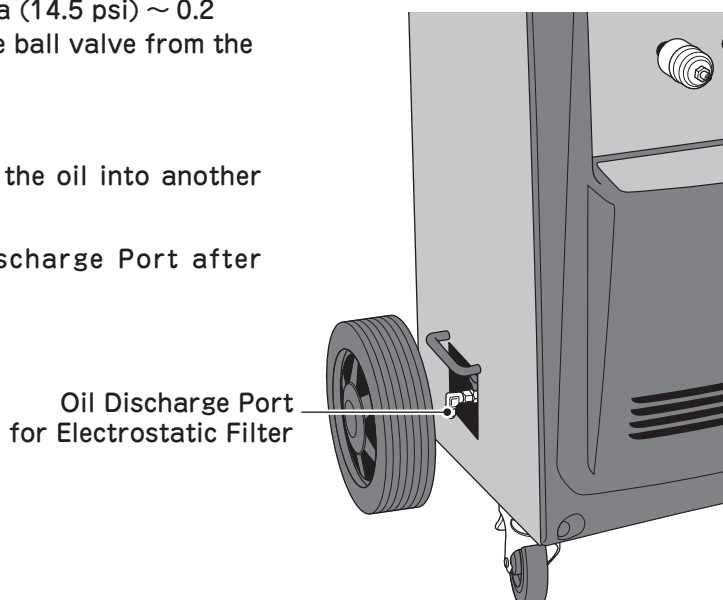

ECOcycle Aurora II

Warm Up Operation

When the ambient temperature is under 10°C, this unit needs a warm up operation to operate efficiently.

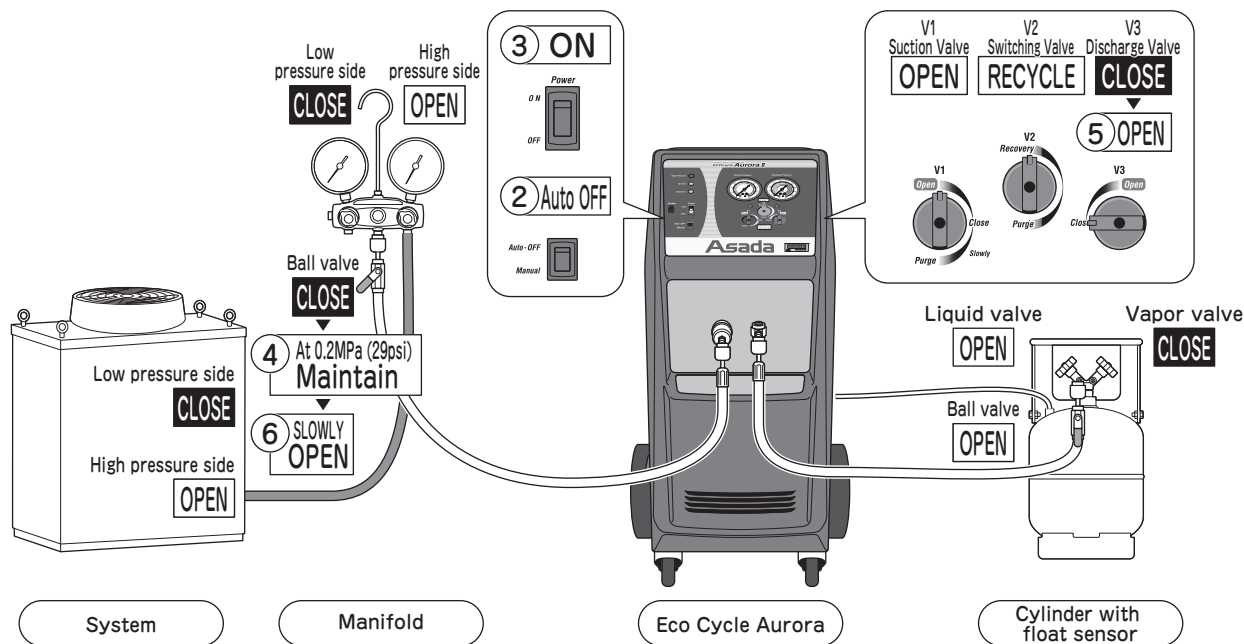

- ① Connect hoses as above after carry out Page 11 " 2) Evacuation of the unit and the hoses"
- ② Set the Auto Shut-off/Manual Mode Setting to [Auto-Shut OFF] position.
- ③ Set Power Switch to [ON].
- ④ Adjust suction pressure around 0.2 MPa (29psi) by opening the ball valve of the suction hose from the manifold and keep operating until Discharge Pressure becomes 1.5 MPa (217.5psi).
- ⑤ After ④, turn V3 Discharge valve to [OPEN] position.
- ⑥ Open the suction hose ball valve from the manifold slowly for approximately 20 seconds.
- ⑦ Follow usual Recovery / Reclaim Procedure. From step 5 on page 12.

ECOcycle Aurora II

How to Purge Non Condensable Gases

Leave the Cylinder for more than 2 hours.

- ① Measure the surface temperature of the Cylinder.
- ② Connect the Liquid side of the Cylinder and the high pressure side of the Manifold with a hose.
- ③ See the saturation temperature and pressure chart. (chart1)
- ④ Compare pressure in the chart with pressure of the Cylinder.
- ⑤ If the pressure of the Cylinder is higher by 0.0345 MPa (5 psi) than pressure in the chart, open the Vapor valve of the Cylinder to purge for 15 second.
- ⑥ Leave the Cylinder for 3 minutes and check the pressure again.
- ⑦ Purge the Cylinder repeatedly until the pressure of the Cylinder becomes in the range of ± 0.0345 MPa (5 psi) .

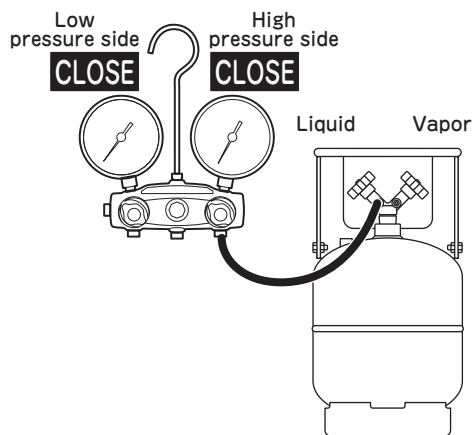

HOW TO USE

Chart1 The saturation temperature and pressure (Pressure is gauge pressure)

Temperature (°C)	Saturation pressure (MPa)		
	R22	R410A	R134a
-10	0.2534	0.4776	0.0998
-8	0.2791	0.5185	0.1161
-6	0.3063	0.5616	0.1335
-4	0.3349	0.6069	0.1519
-2	0.3650	0.6545	0.1714
0	0.3996	0.7044	0.1920
2	0.4298	0.7569	0.2138
4	0.4647	0.8119	0.2369
6	0.5012	0.8695	0.2612
8	0.5395	0.9300	0.2868
10	0.5796	0.9930	0.3138
12	0.6216	1.0590	0.3422
14	0.6654	1.1280	0.3721
16	0.7112	1.2000	0.4035
18	0.7590	1.2750	0.4364
20	0.8089	1.3530	0.4709
22	0.8609	1.4350	0.5071
24	0.9150	1.5200	0.5449

Temperature (°C)	Saturation pressure (MPa)		
	R22	R410A	R134a
26	0.9714	1.6080	0.5846
28	1.0301	1.7000	0.6260
30	1.0911	1.7960	0.6693
32	1.1544	1.8950	0.7145
34	1.2203	1.9980	0.7616
36	1.2886	2.1050	0.8108
38	1.3596	2.2160	0.8621
40	1.4331	2.3320	0.9155
42	1.5093	2.4510	0.9710
44	1.5883	2.5750	1.0289
46	1.6702	2.7030	1.0890
48	1.7549	2.8360	1.1515
50	1.8425	2.9740	1.2164
52	1.9332	3.1160	1.2838
54	2.0269	3.2631	1.3538
56	2.1238	3.4150	1.4265
58	2.2240	3.5720	1.5018
60	2.3275	3.7350	1.5799

Conversion: 0.1MPa = 14.5psi

ECOcycle Aurora II

RECOVERY CYLINDER

Risk of overfilling

- Refrigerant is a high pressure gas and mistakes in use or handling will lead to a serious accident.

1) Relation between the temperature and the pressure of refrigerant in a Cylinder

The pressure of the refrigerant varies depending on the ambient temperature when the refrigerant is filled in a Cylinder.



At this time, lowering of the liquid level by evaporation and rising of the liquid level by specific volume increase occur at the same time and balance.



At this time, rising of the liquid level by liquefaction and lowering of the liquid level by specific volume decrease occur at the same time and balance.

The right graph shows the relation between the pressure (saturation pressure) and the temperature (saturation temperature) for each kind of refrigerant.

This relation between the saturation pressure and the saturation temperature is found when both liquid and vapor exist in a Cylinder. Normally the inside of the Cylinder is under this condition and this chart is useful for field operation.

When a Cylinder is almost full with liquid and no vapor, the pressure rises rapidly even with a slight increase in temperature.

This phenomenon must be avoided in any circumstances.

2) Relationship between the temperature and specific volume of various refrigerant.

Since the specific volume of the liquid differs depending on the type of refrigerant and the degree of expansion of the liquid due to temperature rise also differs, the volume will be different even if the mass of the refrigerant trapped in the cylinder is the same, and liquid sealing easily occurs.

We have shown the relationship tables and graphs of the temperature and liquid specific volume of various CFCs, but caution is required because the specific volume of HFC mixed refrigerant is larger than that of CFC/HCFC and the liquid expansion coefficient due to temperature rise is large.

Please note that R410A/R404A/R507A has much larger specific volume and expansion coefficient than R12/R134a/R22.

In addition, if the oil at the time of recovery remains in the container, the volume with respect to the mass will increase and liquid sealing will occur easily, so be careful.

Saturation pressure and saturation temperature of each type of refrigerant

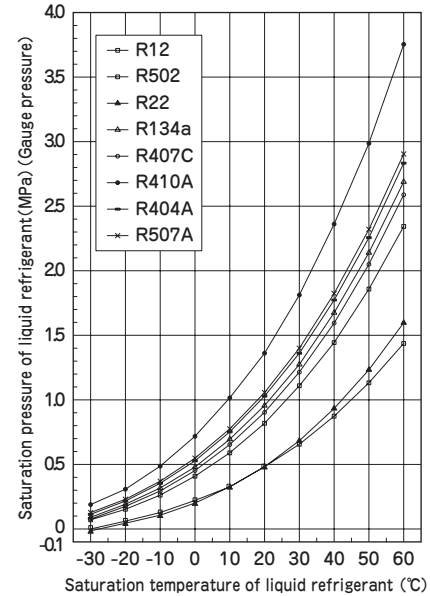

Temperatures and specific volumes of each type of refrigerant

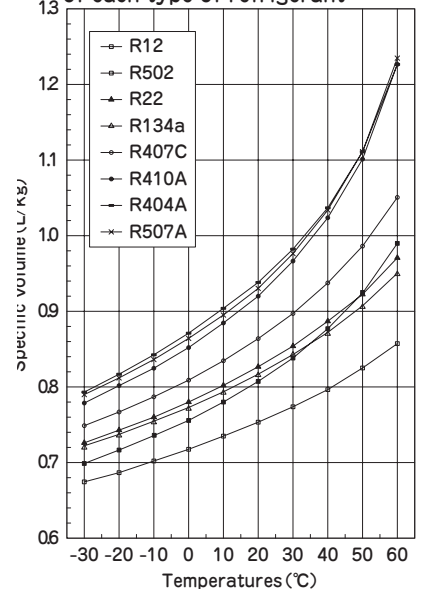

Temperature and pressure of refrigerant in cylinder

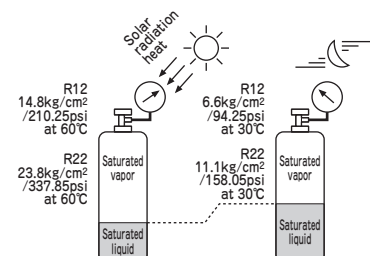

ECOcycle Aurora II

MAINTENANCE & INSPECTION

- Inspect and clean regularly as instructed below and perform correction or replacement timely.

Maintenance

- ① Keep gauges and front panel clean by wiping with a clean cloth.
- ② Keep the air blow hole and condenser clean so as to cool down the condenser efficiently.

Replace Molecular Sieve Pack

Dry Filter is installed at the back side of the unit.

- Replacement period · · · amount of refrigerant 200 – 300 kg

- When using the hour meter as a guide for the replacement time, replace it when the following time has elapsed, depending on the type of refrigerant.

· R134a/R1234yf : About 40 hours

· Refrigerants other than the above: About 20 hours

- ① Recover all of refrigerant from the unit until 0 MPa (0 psi).
- ② Open the Lid of Dry Filter and remove out the Filer Core E.

- ③ Open the Lid of removed Filter Core E (Molecular Sieve Pack) and remove Spring, Mesh Plate, and Filter.

- ④ Take out old Molecular Sieve.

- * No need to take out Filter at the bottom in the Filter Core (Molecular Sieve Pack).

◆ The Hour Meter cannot be reset. As a guide for the replacement time after the second time, judge by the time added to the display time at the time of replacement.

⚠ CAUTION



- ◆ Replacing Molecular Sieve should be done quickly after open the package to avoid spoiling its quality.

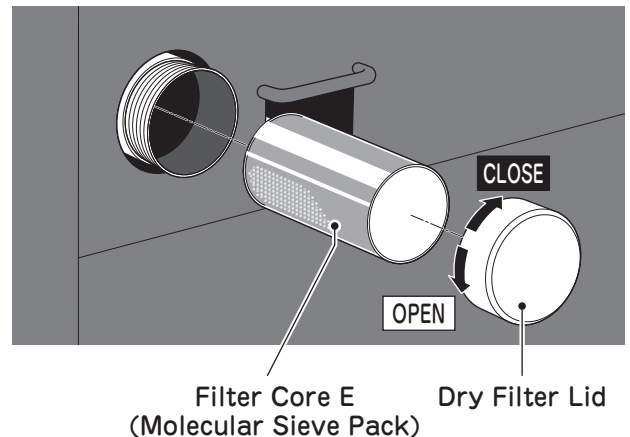

- ⑤ Fill up all of new Molecular Sieve Pack (AR222) to Filter Core.
- ⑥ Set Mesh Plate and Spring in Filter Core and close the lid.
- ⑦ Make sure that the Mesh Plate is properly installed when viewed from the Mesh Plate side of Filter Core.
- ⑧ Put new Filter Core in the unit and close the lid surely with holding spring.
- ⑨ Check for leakage, referring to page 22, Confirmation of Leak.

< Internal structure of the Filter Core E >

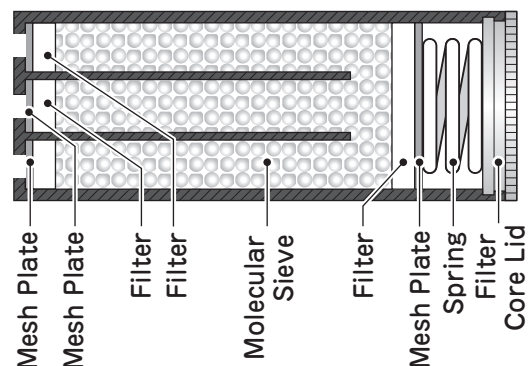

⚠ CAUTION



- ◆ When replacing old Molecular sieve of "AR179E AR filter core E" with a new "AR222 Molecular sieve pack", make sure that the "mesh plate" inside the filter core E is installed correctly horizontally.
- ◆ Details of the verification method, please refer to the "Notes of the time to put the AR222 AR Molecular sieve pack" that comes with the "AR222 Molecular sieve pack".

ECOcycle Aurora II

In Case of Reclaim Other Refrigerant

- ① Replace Molecular Sieve Pack referring to page 20 after discharging oil referring to page 16.
- ② Turn V1 Suction valve to [Close] position. V2 Switching valve and V3 Discharge valve position does not matter.
- ③ Connect a vacuum pump to Oil Discharge Port of Oil Separator.
- ④ Turn on the vacuum pump and open the valve of Oil Discharge Port for Oil Separator.
- ⑤ After one hour evacuation, close the valve of Oil Discharge Port for Oil Separator and turn off the vacuum pump.

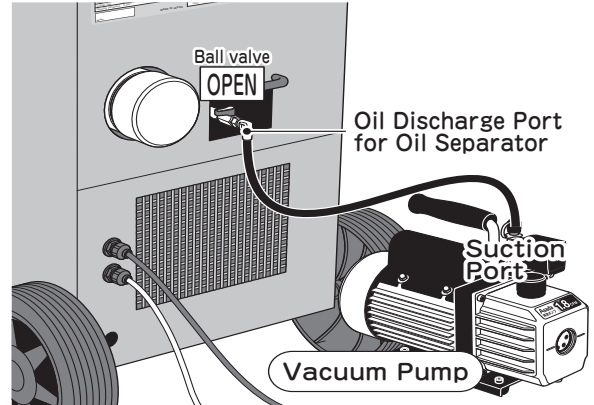

VARIOUS INSPECTION METHODS

- Regularly inspect and clean as follows, and repair or replace as necessary.

Daily Inspection Before Work

- Inspection and replacement of peripheral devices for safe use.
 - The charging hose is a consumable item. Even if the appearance is normal, **replace it after about every 5 years.**
 - Be sure to check the manifold, cooling unit, and header for **any abnormalities or leaks before starting work.**

- ① Check damage on the plug and cord.
- ② Check for scratches or cracks on the outer surface of each hose.
- ③ Confirm that all gaskets on the hoses are not worn or exhausted.
- ④ Confirm the unit starts normally when Power Switch is turned on.
- ⑤ Confirm the unit stops when Power Switch is turned off.
- ⑥ Make sure that the aluminum fin of the condenser on the back of this unit is not clogged.

Inspection of Reclaim function

- ① Remove cap of Suction Port and Discharge Port.
- ② Turn V1 Suction valve to [OPEN] position.
Turn V2 Switching valve to [RECYCLE] position.
Turn V3 Discharge valve to [OPEN] position.
- ③ Set Power Switch to [ON].
- ④ Confirm suction from Suction.
- ⑤ Confirm discharge from Discharge Port.

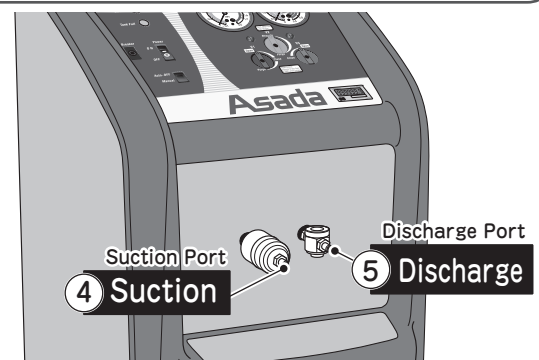

ECOcycle Aurora II

Inspection of Purge function

- ① Remove cap of Suction Port and Discharge Port.
- ② Turn V1 Suction valve to [PURGE] position.
Turn V2 Switching valve to [PURGE] position.
Turn V3 Discharge valve to [OPEN] position.
- ③ Set Power Switch to [ON].
- ④ Confirm Suction Pressure is under 0 MPa (0 psi).
- ⑤ Confirm no air flow from Discharge Port.

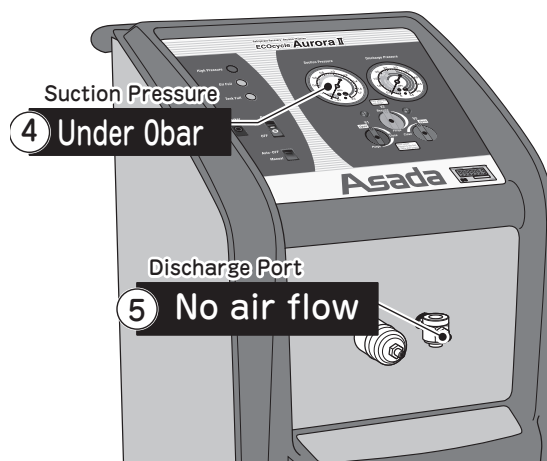

Inspection of High Pressure Switch Function

- ① Remove cap of Suction Port and Discharge Port.
- ② Turn V1 Suction valve to [OPEN] position.
Turn V2 Switching valve to [RECYCLE] position.
Turn V3 Discharge valve to [CLOSE] position.
- ③ Set Power Switch to [ON].
- ④ After a while (Discharge pressure: 2.9MPa / 425psi), High Pressure Shut-off function makes the unit stop automatically and Warning Lamp is turned on.

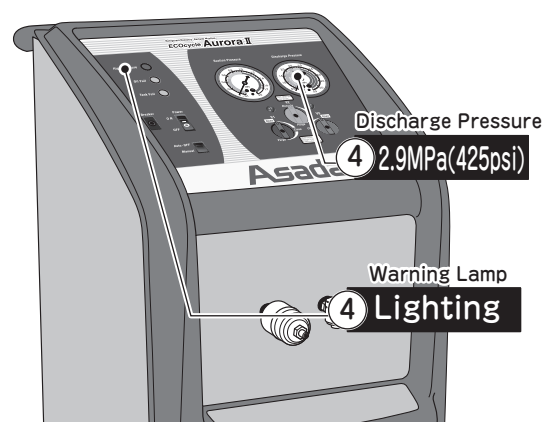

Inspection of Leak

- ① Remove cap of Suction Port and Discharge Port.
- ② Turn V1 Suction valve to [OPEN] position.
Turn V2 Switching valve to [RECYCLE] position.
Turn V3 Discharge valve to [CLOSE] position.
- ③ Set Power Switch to [ON].
- ④ After a while (Discharge pressure: 2.9MPa / 425psi), High Pressure Shut-off function makes the unit stop automatically and Warning Lamp is turned on.
- ⑤ Leave this condition for 1 to 2 minutes and confirm that there is no significant pressure drop. (Slight pressure decrease due to pressure balance is normal.)



ECOcycle Aurora II

BEFORE REQUESTING REPAIR OR SERVICES

Symptom	Cause	Solution
The unit does not start.	① The power cord is not plugged in.	① Plug Power Cord in properly.
	② The safety cable is not connected.	② Connect the safety cable.
	③ The unit stops due to High Pressure Shut-off function.	③ Reduce Discharge Pressure.
	④ Breaker is tripped.	④ Reset Breaker.
	⑤ The thermal protector is tripped due to the motor overheating.	⑤ Wait until the motor cools down.
	⑥ The cylinder is full.	⑥ Replace the cylinder
	⑦ The float sensor of the cylinder is out of order.	⑦ Repair
	⑧ The motor has burned out	⑧ Repair
	⑨ The compressor is locked.	⑨ Repair
	⑩ Wiring fault or disconnection.	⑩ Repair
	⑪ The high pressure switch is out of order.	⑪ Repair
	⑫ The low pressure switch is out of order.	⑫ Repair
The unit stops soon after starting.	① The ball valve on the discharge hose is closed.	① Open the ball valve.
	② The liquid valve of the cylinder to be charged is closed.	② Open the liquid valve.
	③ The pressure in the cylinder to be charged is high.	③ Cool the cylinder.
	④ Voltage drop	④ Connect to a 220V to 240V power source. Use an appropriate extension cord.
The recovery speed is slow or the unit does not recover.	① The suction hose is connected to the vapor port.	① Connect it to the liquid port.
	② Filter (TF011) is clogged.	② Clean or replace Filter (TF011).
	③ The pressure in the cylinder to be charged is high.	③ Cool the cylinder.
	④ The hose has a core depressor.	④ Remove the core depressor in the hose.
	⑤ The refrigerant in the cylinder is condensing at low temperature.	⑤ Wait until operating temperature is reached.
	⑥ The low pressure switch trips.	⑥ Pressurize the suction port side. Switch the shut-off mode setting to "Manual".
	⑦ Piston Seal Kits in the compressor are worn out.	⑦ Repair.
	⑧ The suction and discharge valves of the compressor work abnormally.	⑧ Repair.
The unit does not restart.	① The motor is overheated.	① Wait until the motor cools down.
	② The difference in pressure between the suction side and the discharge side is too large as the pressure in the cylinder is high.	② Balance the pressure.
	③ Breaker is tripped.	③ Reset Breaker.
	④ The low pressure switch trips.	④ Raise Suction Pressure higher than atmospheric pressure.
Oil tank full lamp is on.	① Oil Separator is flooded with oil.	① Discharge oil operation following Page 16.

ECOcycle Aurora II

BEFORE REQUESTING REPAIR OR SERVICES

Symptom	Cause	Solution
Oil full fill lamp lights up when R134a is recycling.	① Liquid R134a, R12, R1234yf accumulates in Oil Separator	① Refer to page 13.
The high pressure switch does not work.	① The high pressure switch is out of order.	① Repair.
	② Faston terminals are disconnected.	② Connect the faston terminals properly.
The high pressure switch works even at low pressure.	① The high pressure switch is out of order.	① Repair.
The low pressure switch does not work.	① Auto/Manual Shut-off Mode Setting sets at "Manual" side.	① Switch the shut-off mode setting to "Auto Shut-off".
	② The low pressure switch is out of order.	② Repair.
The purity of the reclaimed refrigerants is not good enough.	① Molecular Sieve is contaminated.	① Replace Molecular Sieve Pack (AR222) referring to page 20 and Filter (TF011).
	② The O-ring in Dry Filter Housing is damaged.	② Replace O-ring.
Refrigerants leak from the unit.	① The charging hose and the hose packing are not in good condition.	① Replace the charging hose and packing.
	② The lid of Dry Filter Housing is loose.	② Close the lid tight.
	③ Filter and Sight Glass are loose.	③ Tighten Filter and Sight Glass.
	④ The valve of Oil Discharge Port is open.	④ Close the valve and put a cap on the port.

ECOcycle Aurora II

ELECTRIC WIRING DIAGRAM

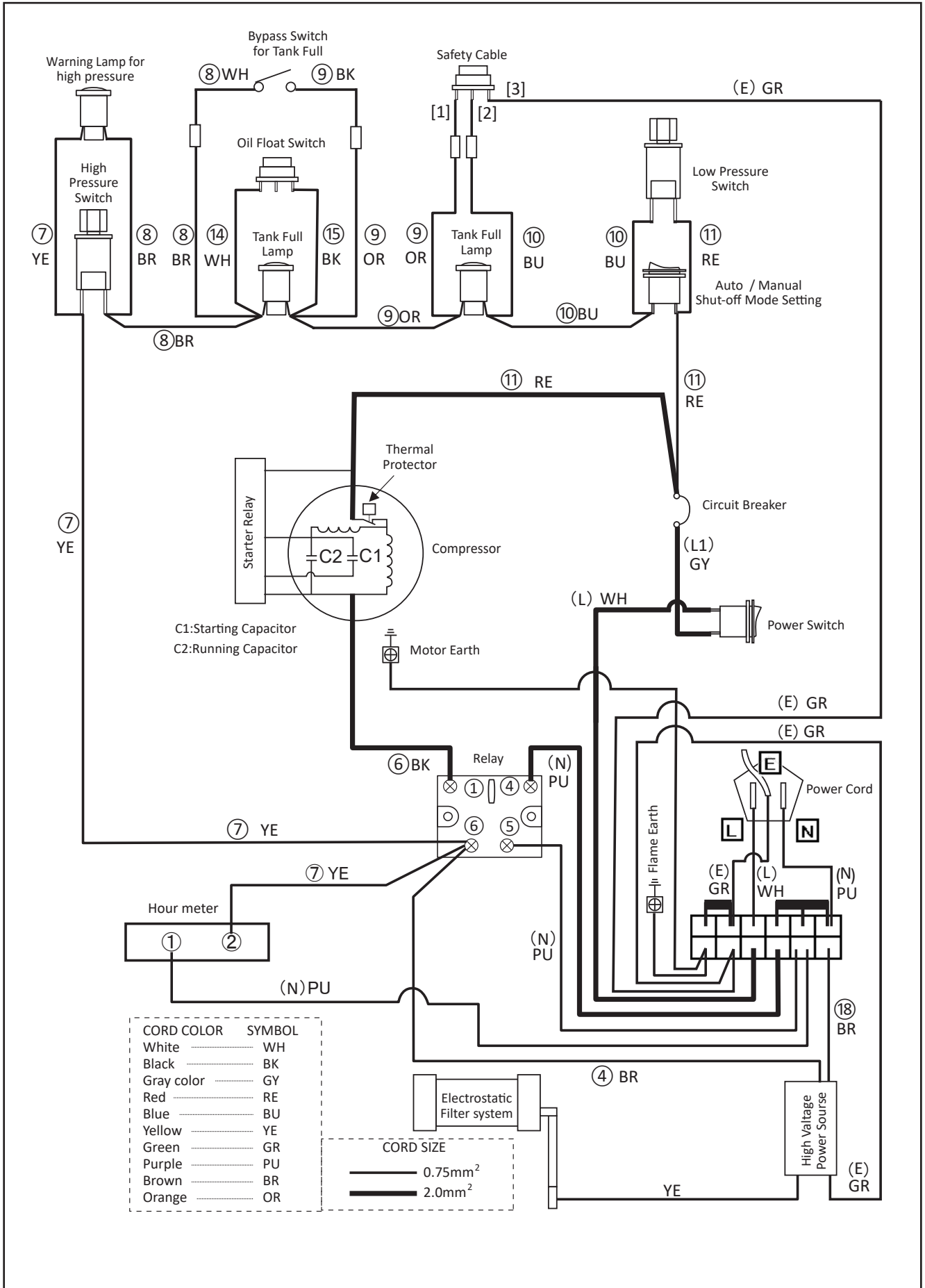

ELECTRIC WIRING DIAGRAM

ECOcycle Aurora II

FLOW DIAGRAM

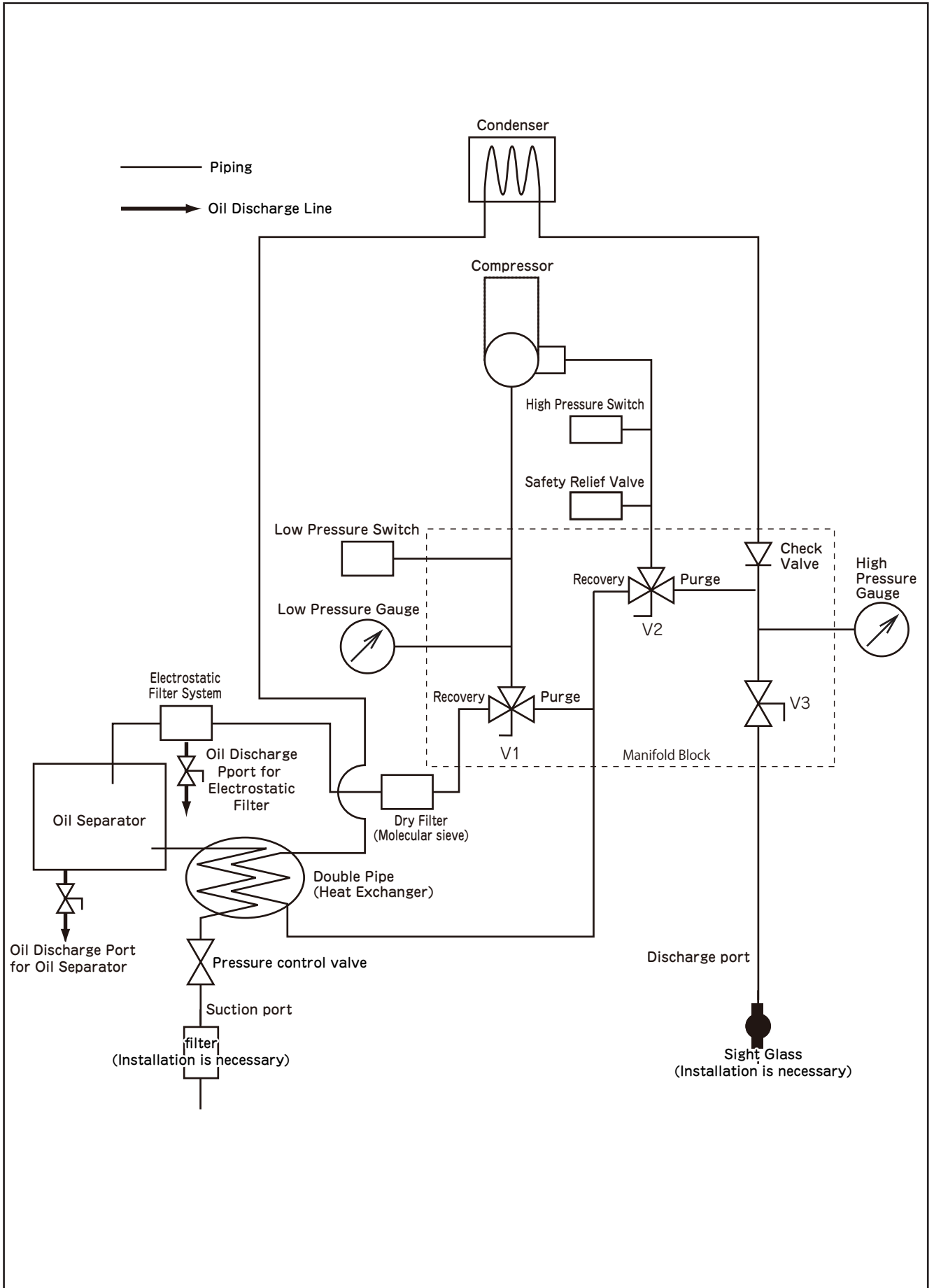

●Customer Memo Please fill in for your record in the future
The information is helpful for inquiry and ordering parts.

Products Number:

Date Purchased:

Store Purchased the Unit:

Asada
ASADA CORPORATION

3-60, Kamiida, Nishi-Machi, Kita-Ku, Nagoya, Japan 462-8551

TEL +81-52-914-1062

FAX +81-52-914-1065

URL <http://www.asada.co.jp>

E-mail: trade@asada.co.jp